

Paßfeder  
feather key  
DIN 6885 - 3x3x18

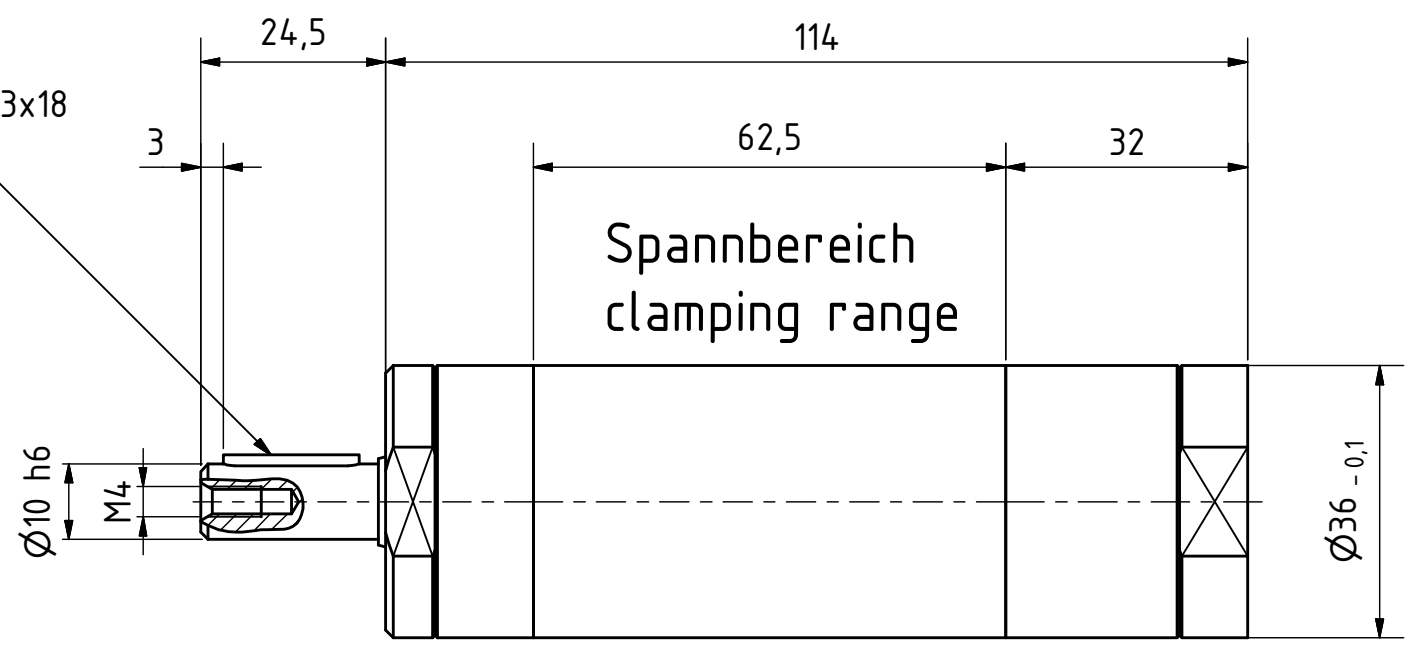

MRD 25-2200 29945127		<b>MANNESMANN DEMAC</b>
Änderungsstand: -	14.09.2018	