

Passfeder
feather key
DIN 6885 - 3x3x18

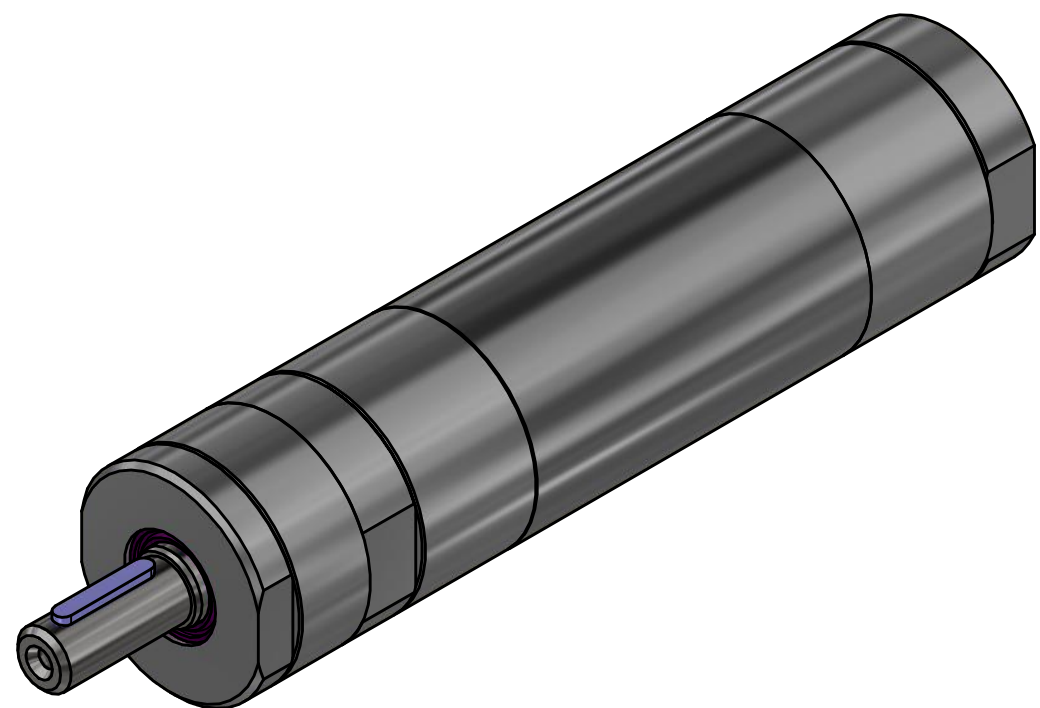
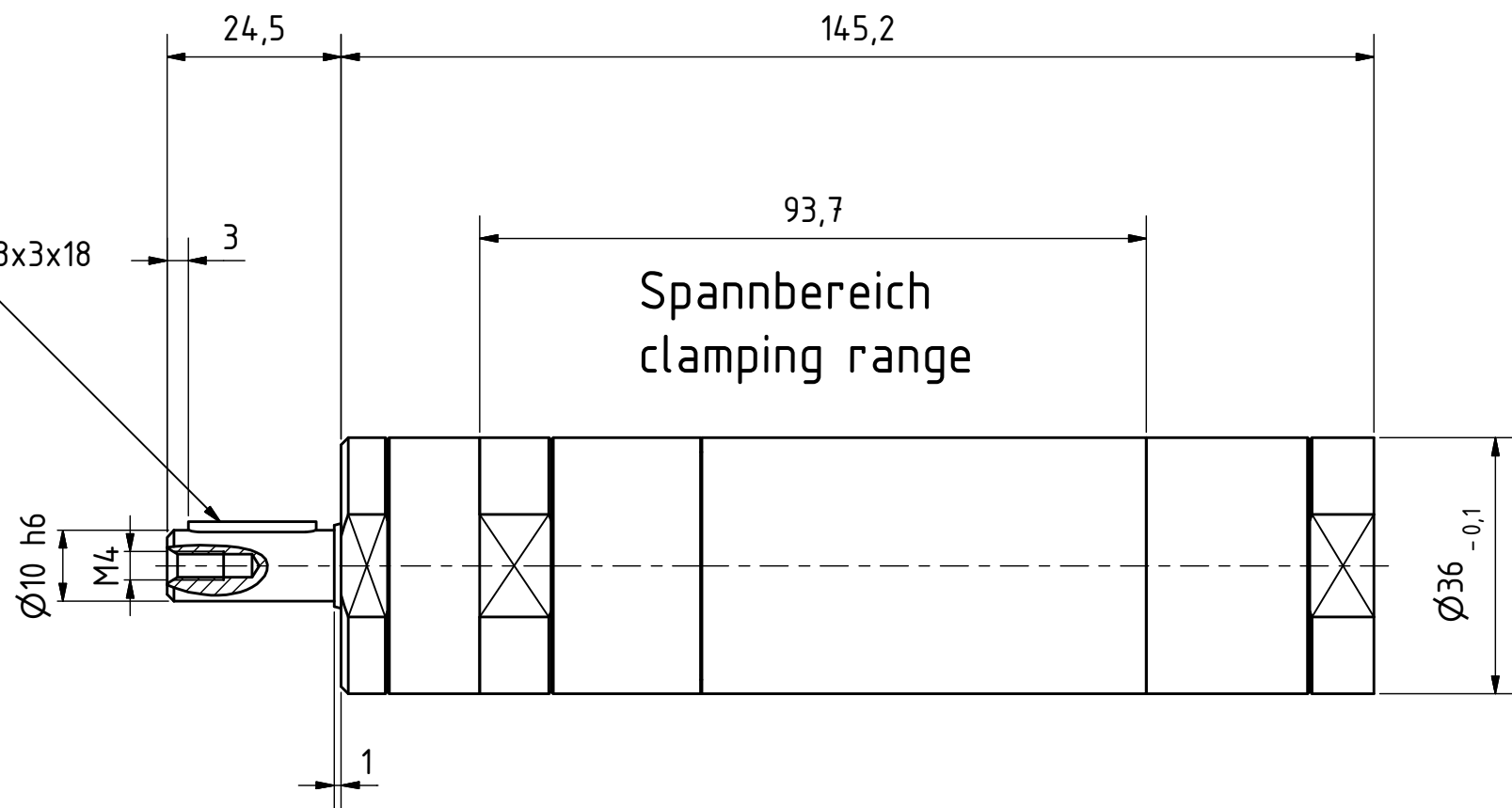

MRD 25-235
29945177

MANNESMANN
DEMAC

Änderungsstand:

07.11.2018