

Passfeder
feather key
DIN 6885 - 6x6x32

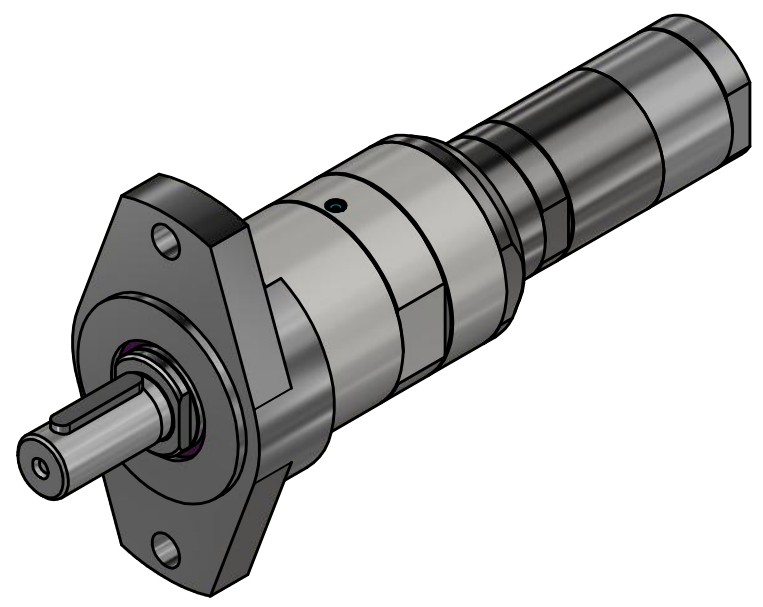
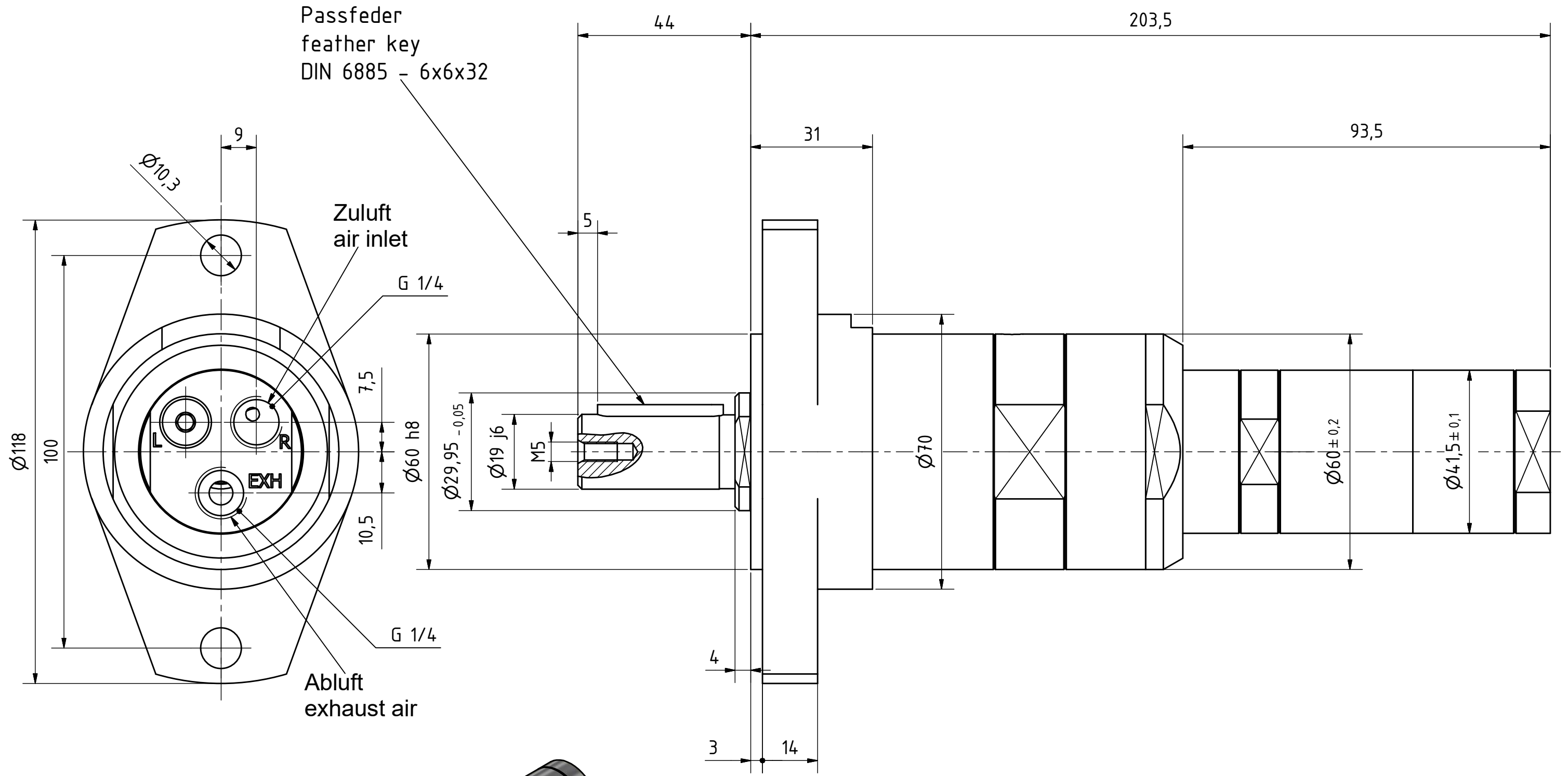

MRD 38-40 F100
60031827

MANNESMANN
DEMAG

Änderungsstand: - 14.05.2018