

Passfeder  
 feather key  
 DIN 6885 - 5x5x18

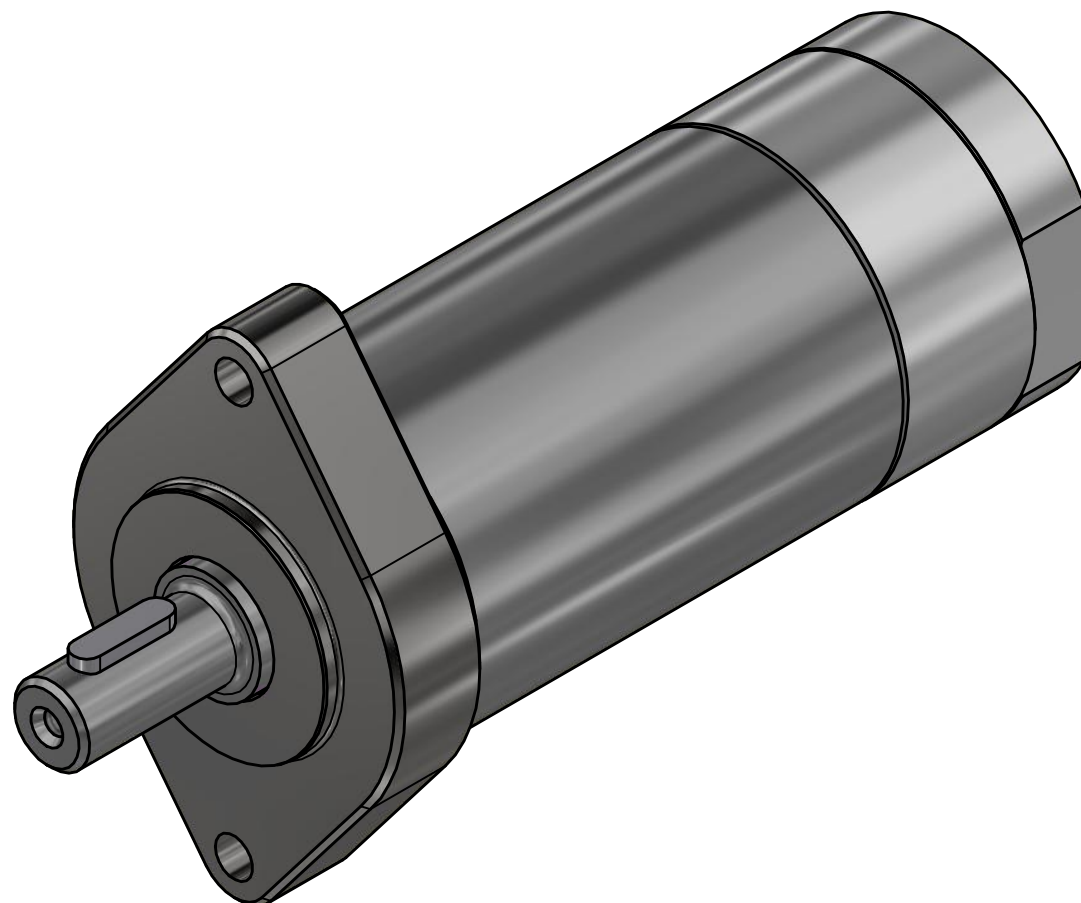
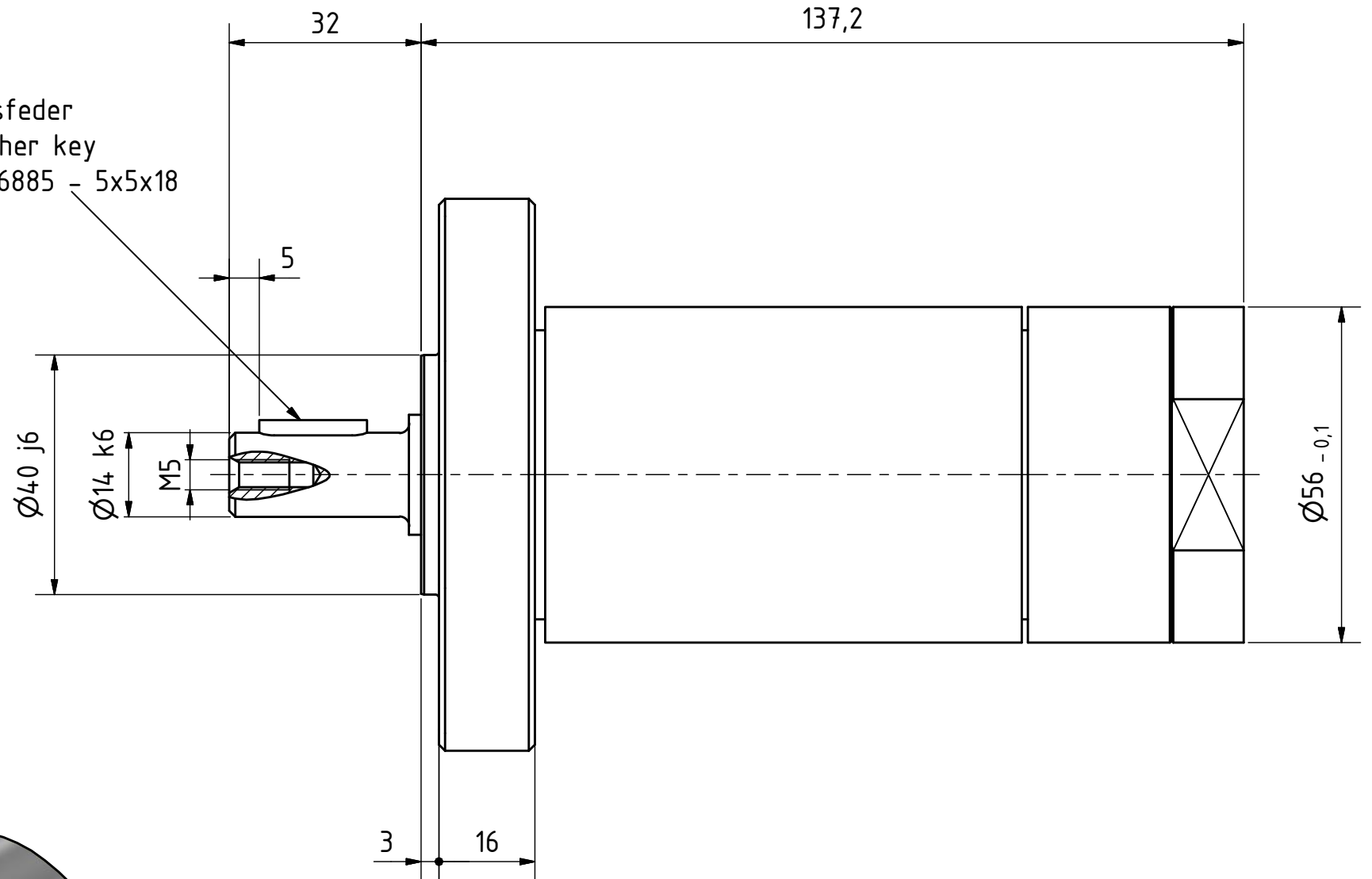

MRD 55-2200 F77  
 29906317

**MANNESMANN**  
**DEMAC**

Änderungsstand: - 16.11.2018