

Passfeder
 feather key
 DIN 6885 - 5x5x18

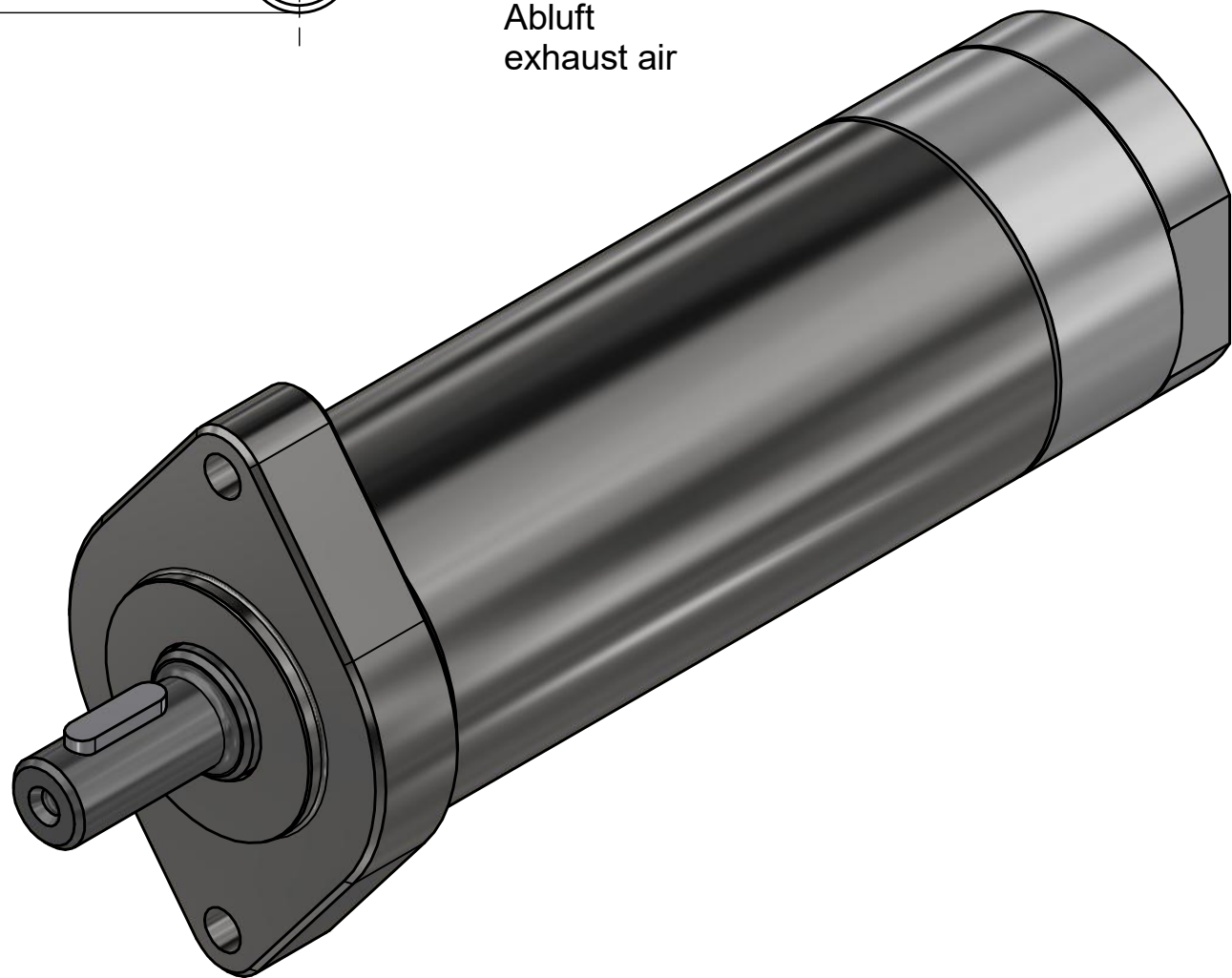
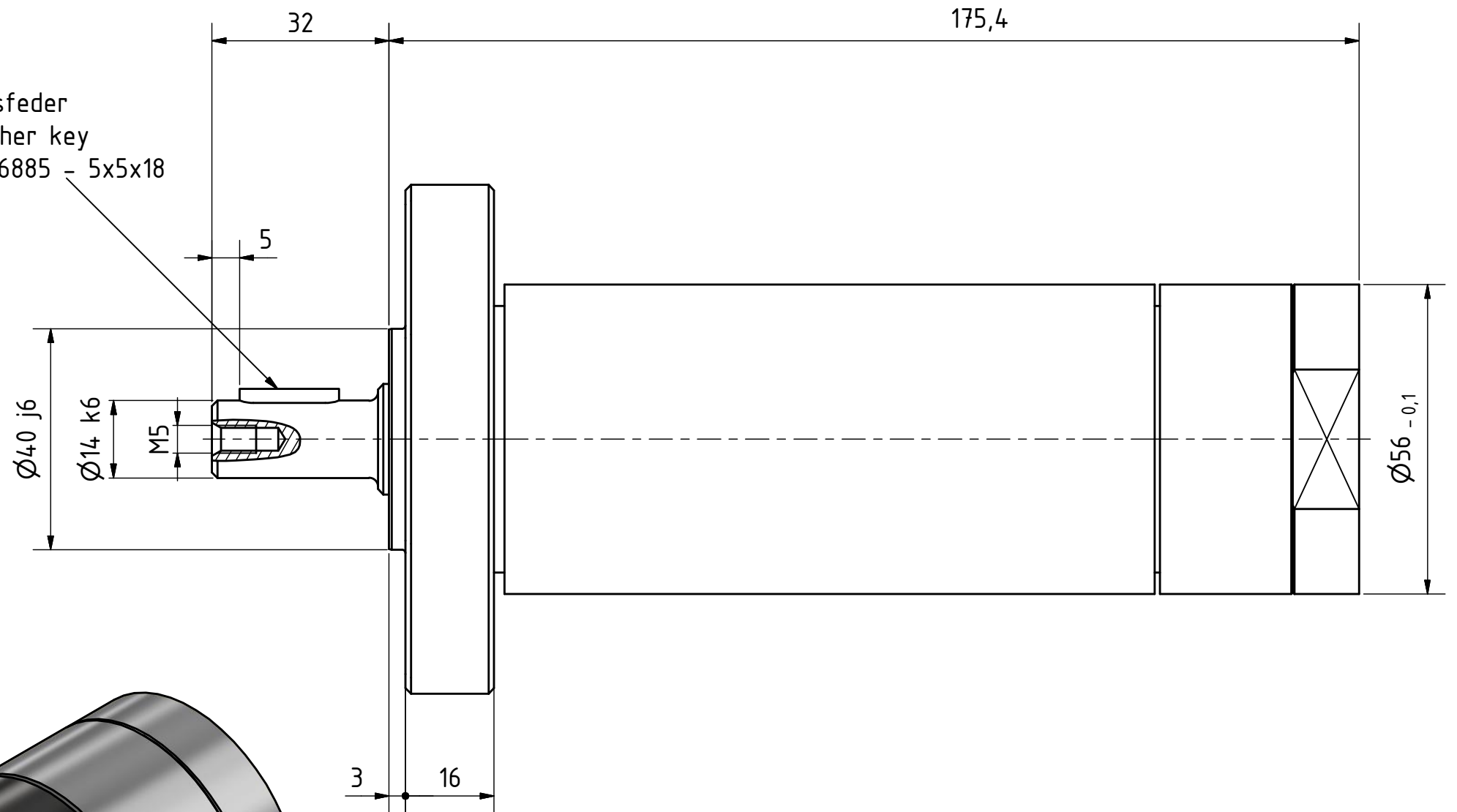

MRD 55-650 F77
 29906337

MANNESMANN
DEMAC

Änderungsstand: - 16.11.2018