

Passfeder
feather key
DIN 6885 - 5x5x30

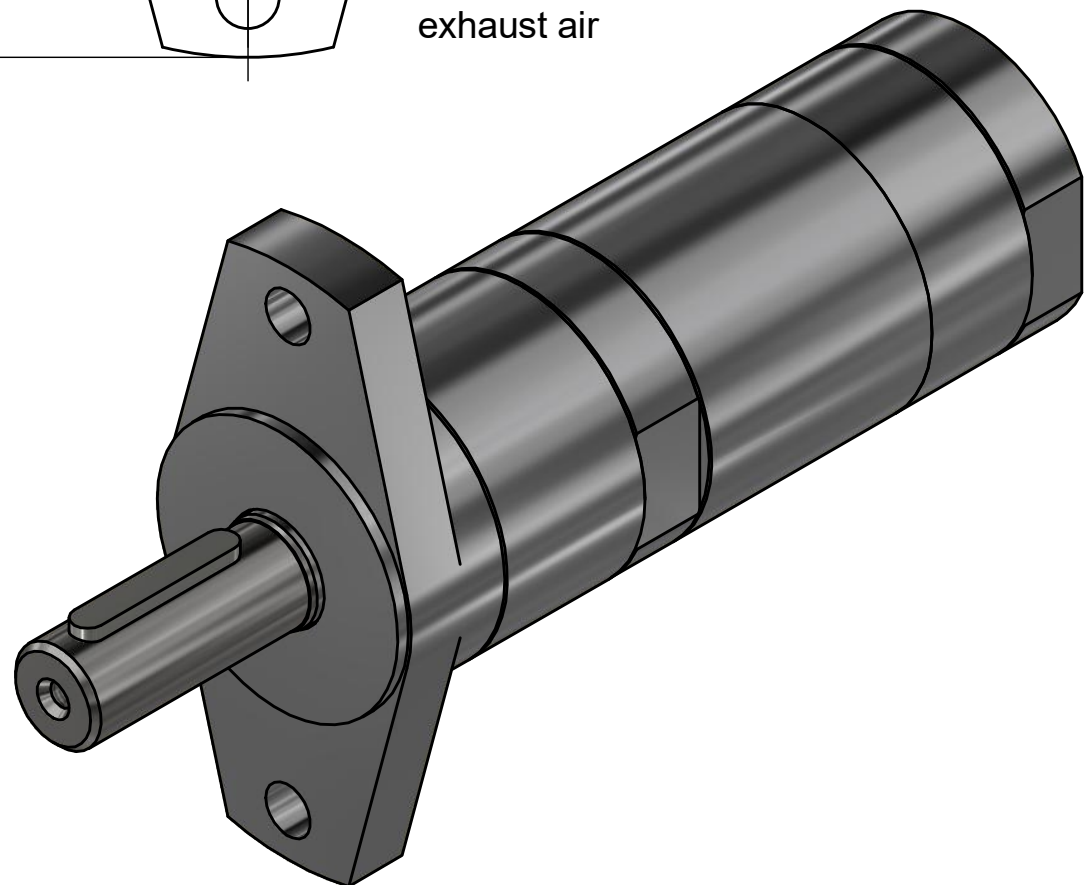
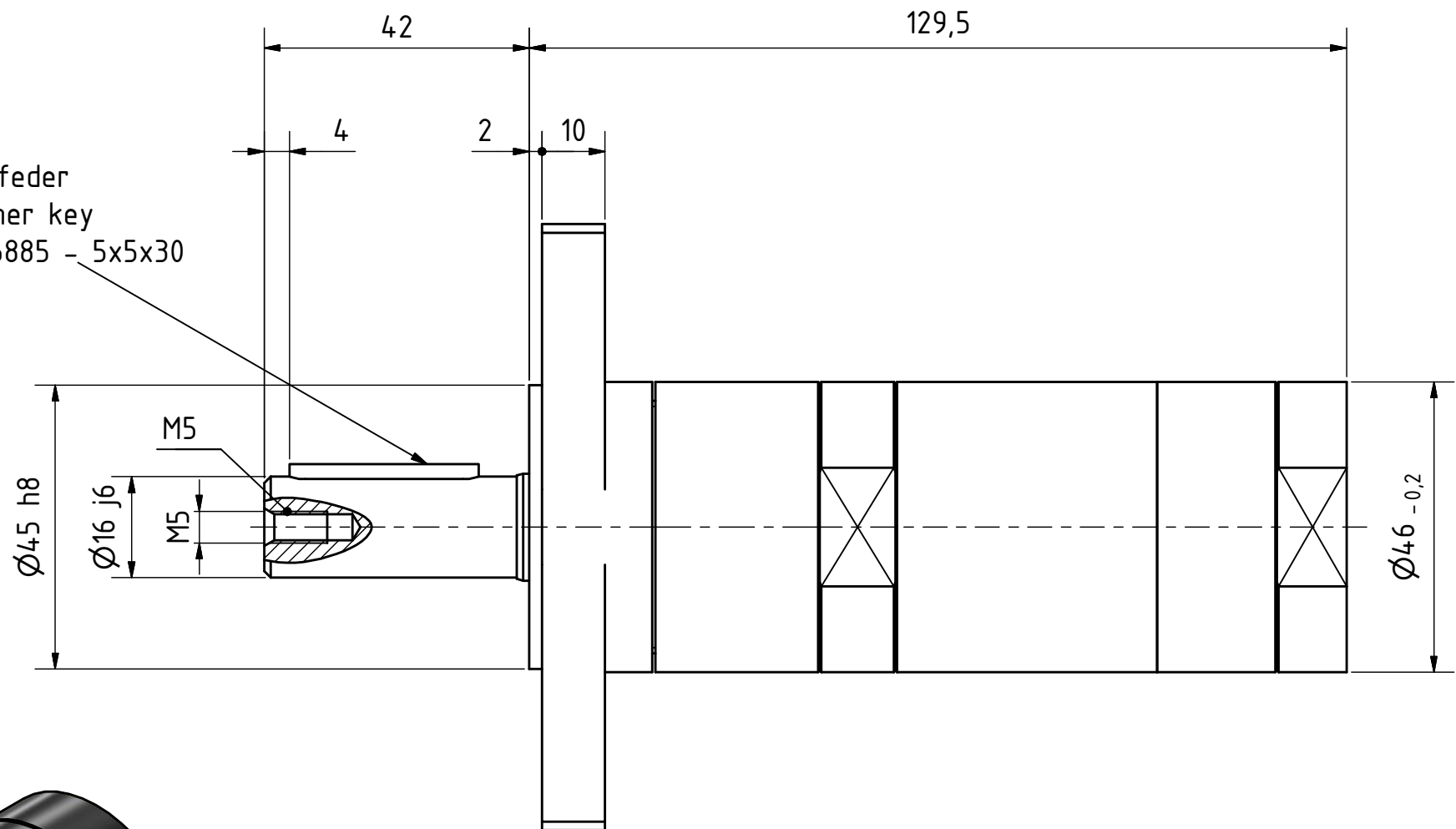

MRD 65-1300 F80
60031487

MANNESMANN
DEMAG

Änderungsstand: -

17.01.2018