

Passfeder
feather key
DIN 6885 - 5x5x30

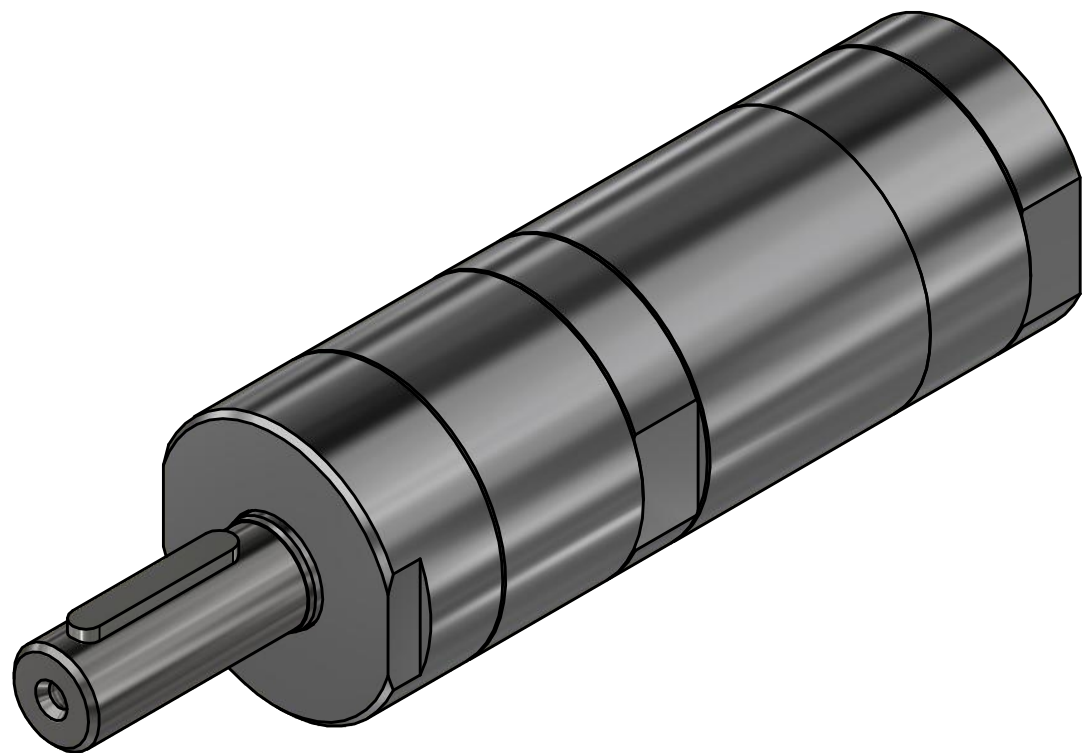
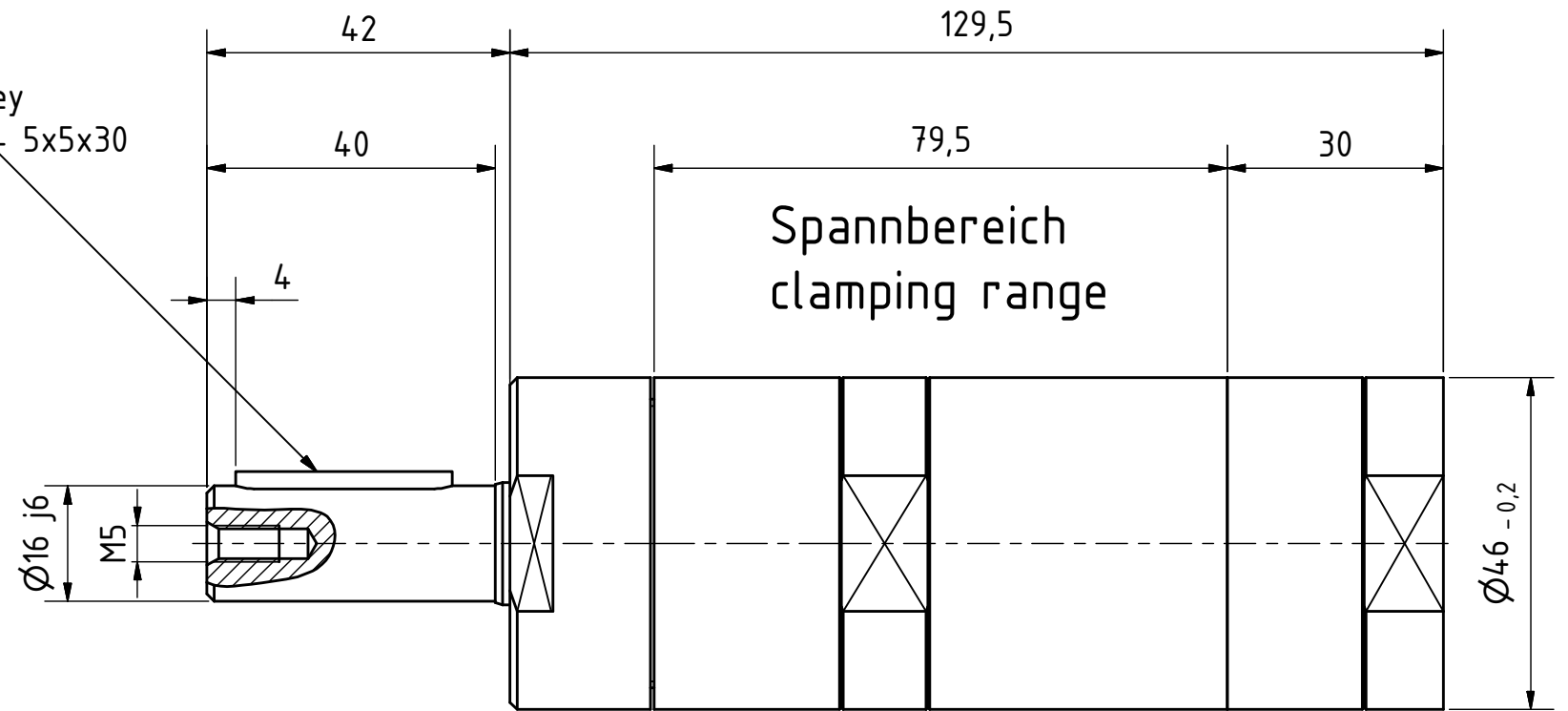

MRD 65-1300
60024587

MANNESMANN
DEMAG

Änderungsstand: - 22.01.2018