

Passfeder
feather key
DIN 6885 - 5x5x30

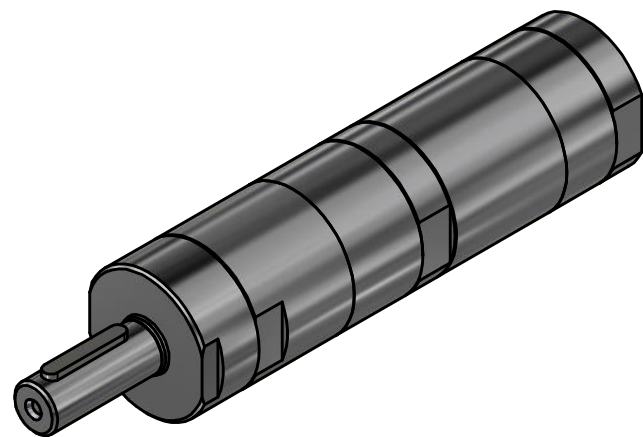
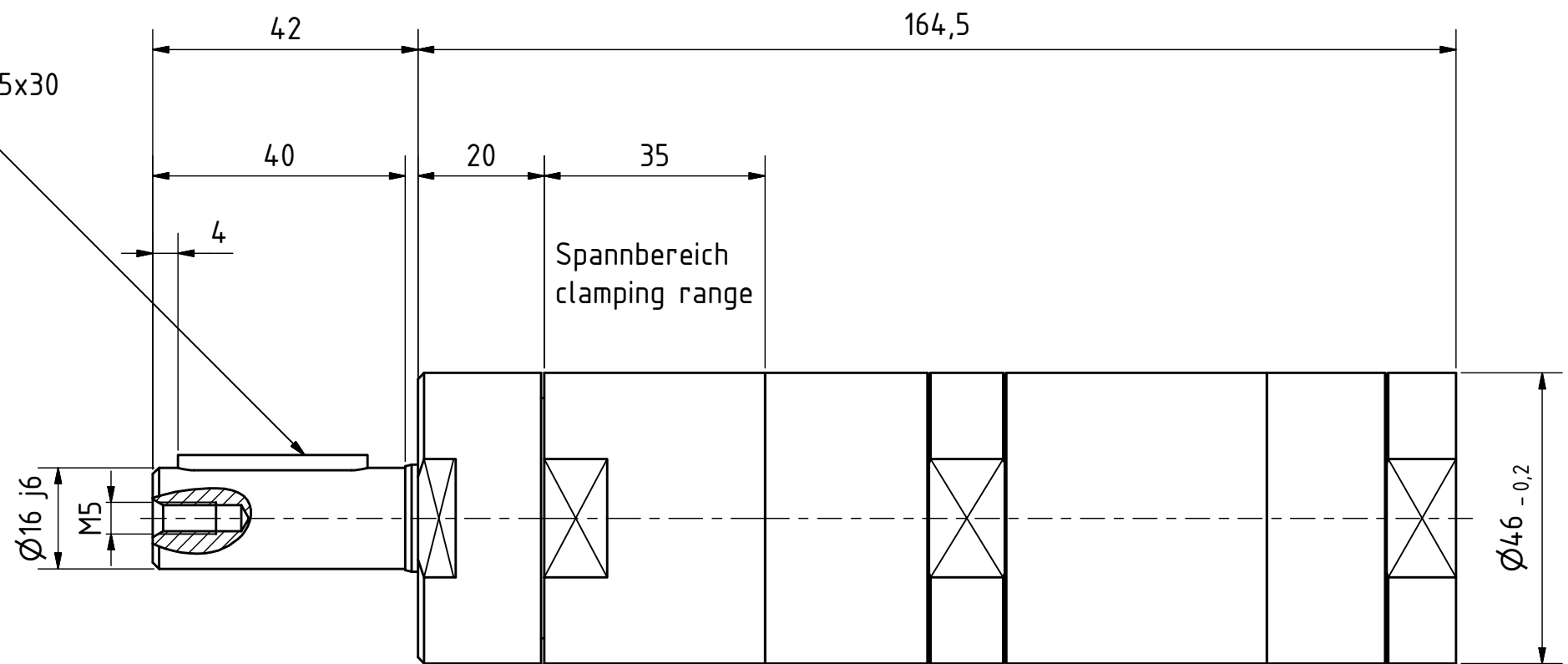

MRD 65-500
60024607

MANNESMANN
DEMAG

Änderungsstand: -

30.01.2018