

Passfeder
feather key
DIN 6885 - 3x3x18

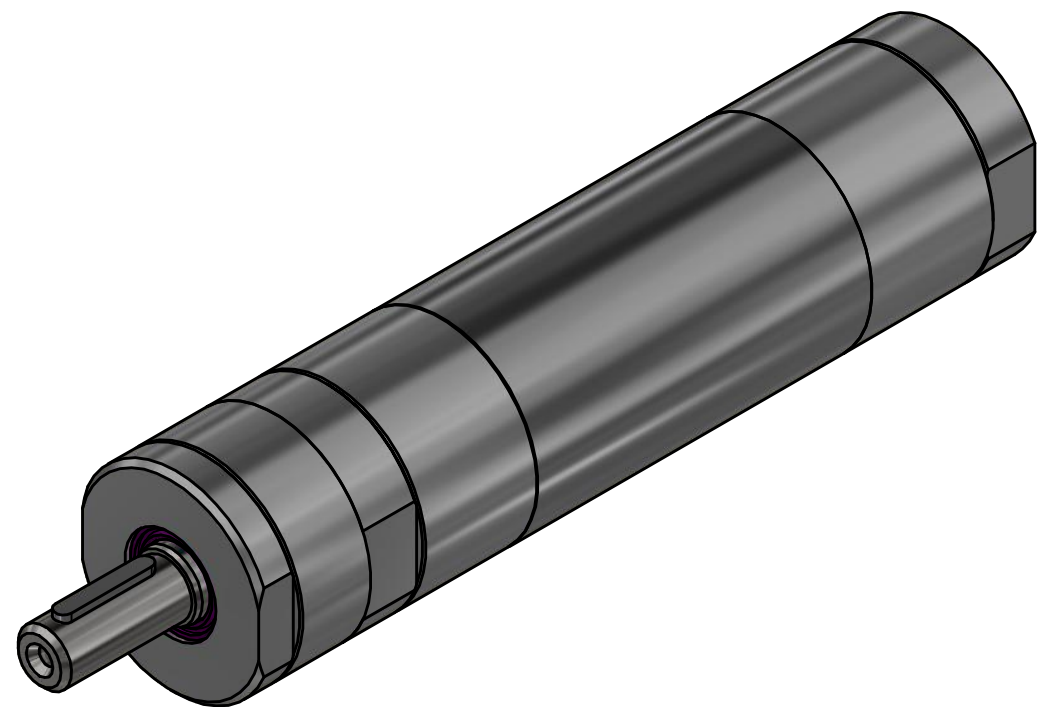
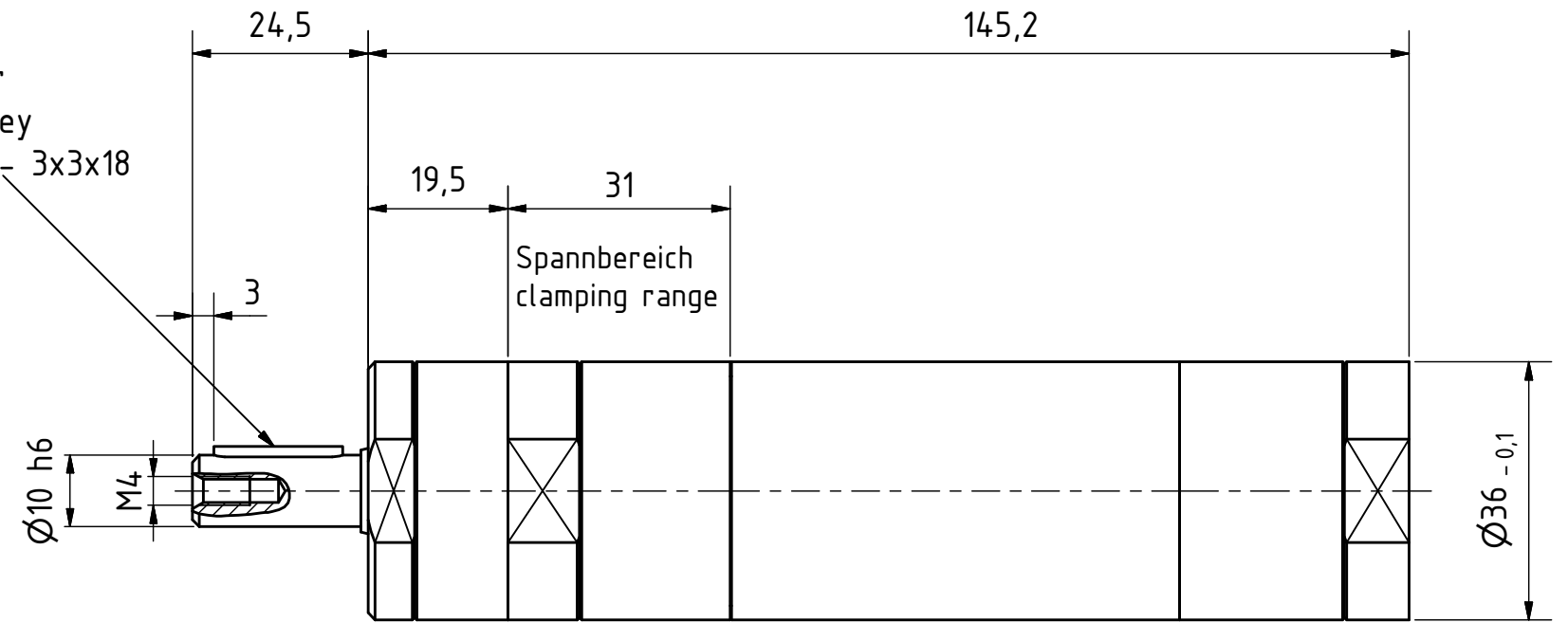

MUD 16-240
29945067

MANNESMANN
DEMAC

Änderungsstand: -

12.11.2018