

Passfeder
feather key
DIN 6885 - 3x3x18

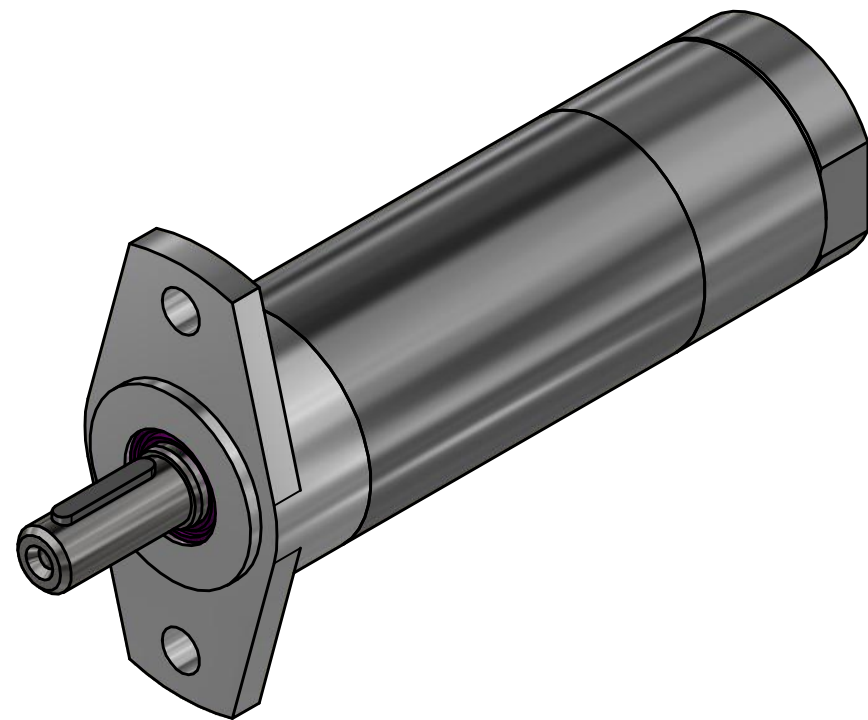
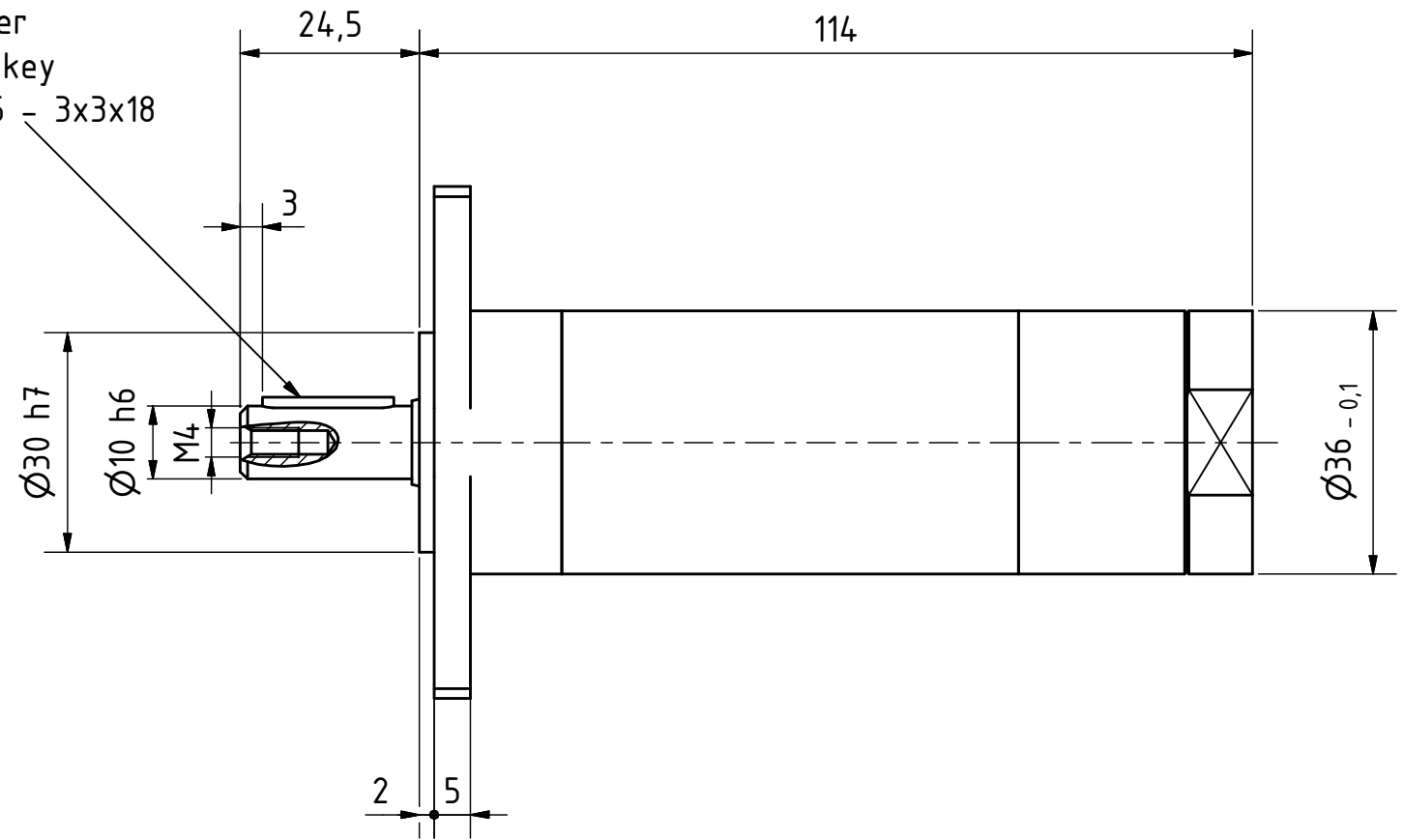

MUD 16-6500 F55
60030287

MANNESMANN
DEMAG

Änderungsstand: -

12.11.2018