

Passfeder
feather key
DIN 6885 - 3x3x18

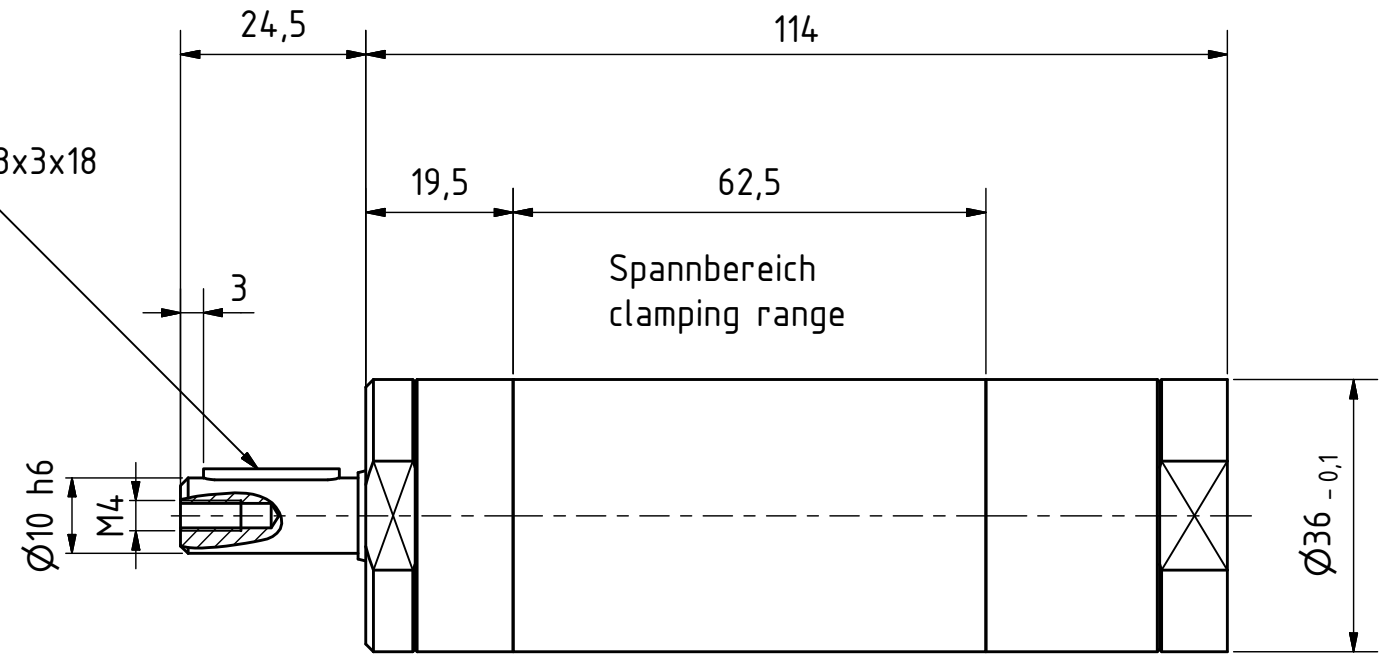

MUD 16-650
29945047

MANNESMANN
DEMAC

Änderungsstand: -

12.11.2018