

Paßfeder
feather key
DIN 6885 - 4x4x25

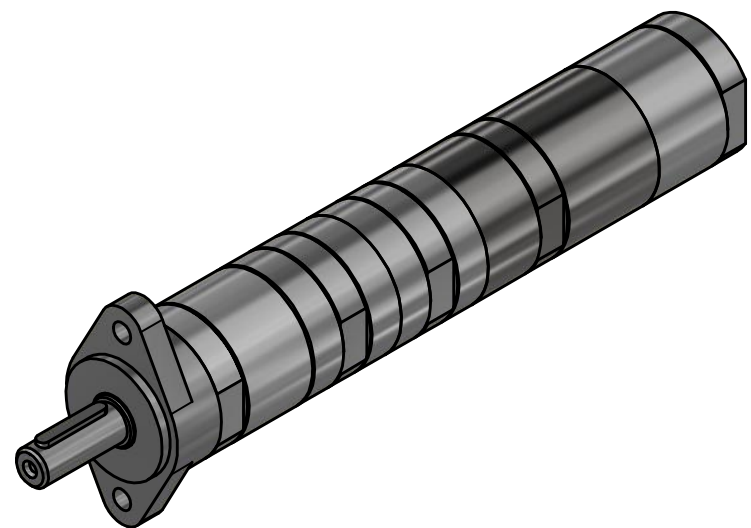
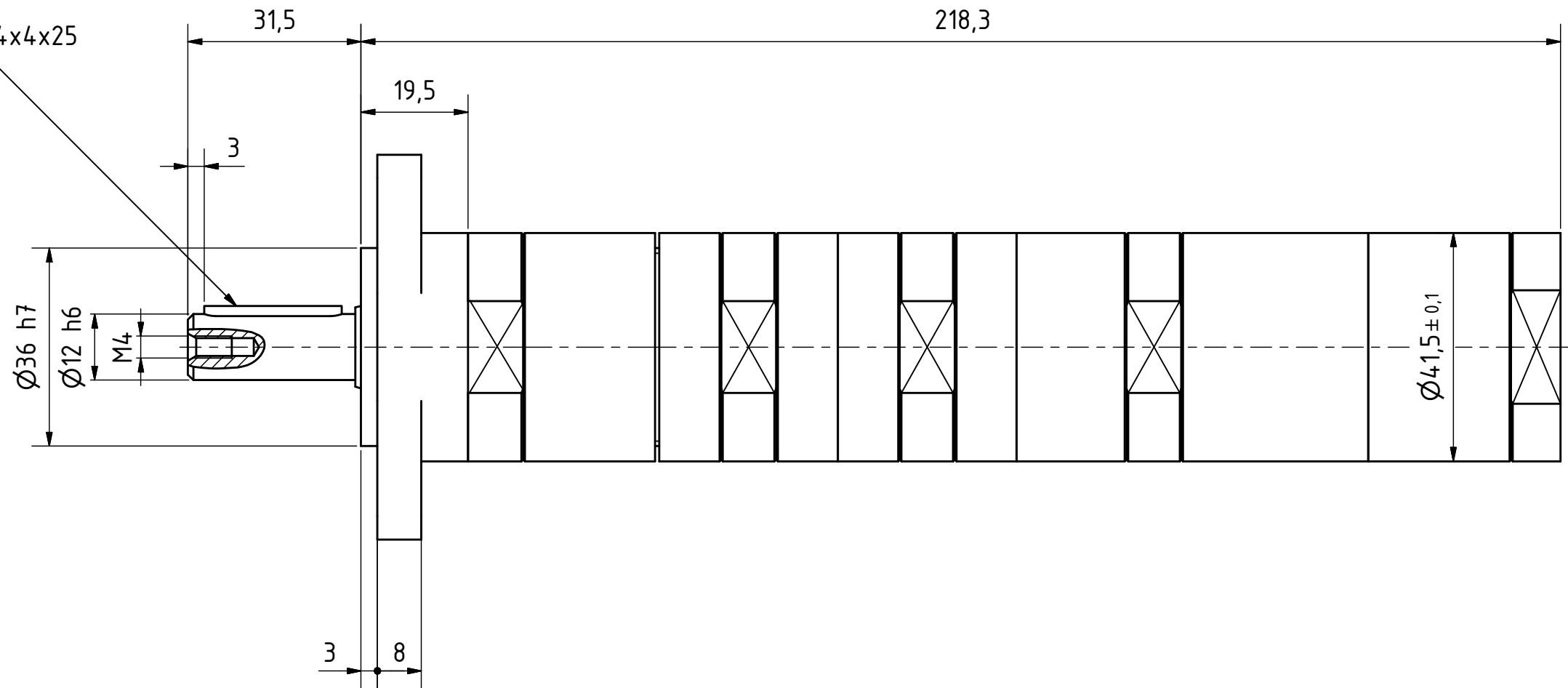
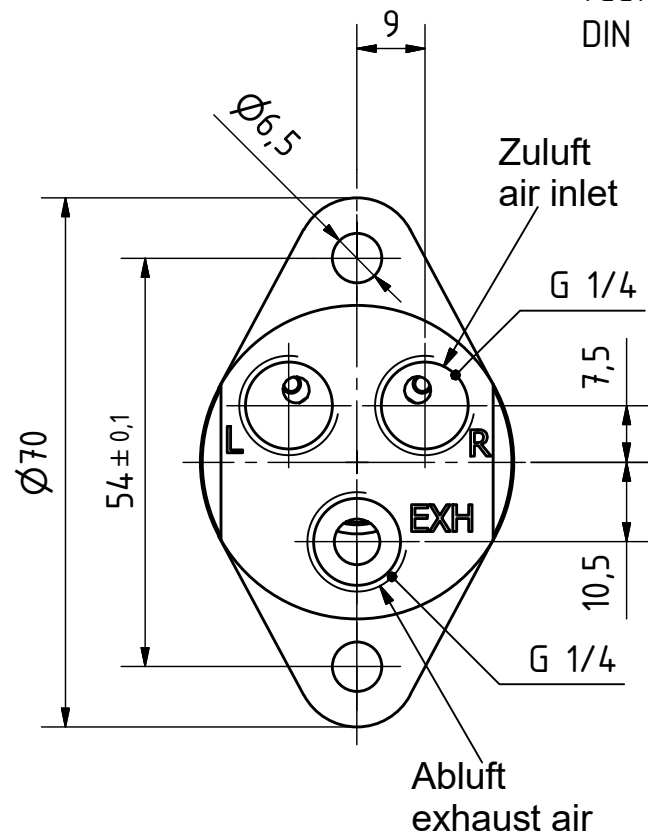

MUD 23-37 F54
60019957

MANNESMANN
DEMAC

Änderungsstand: - 09.08.2018