

Passfeder
feather key
DIN 6885 - 6x6x32

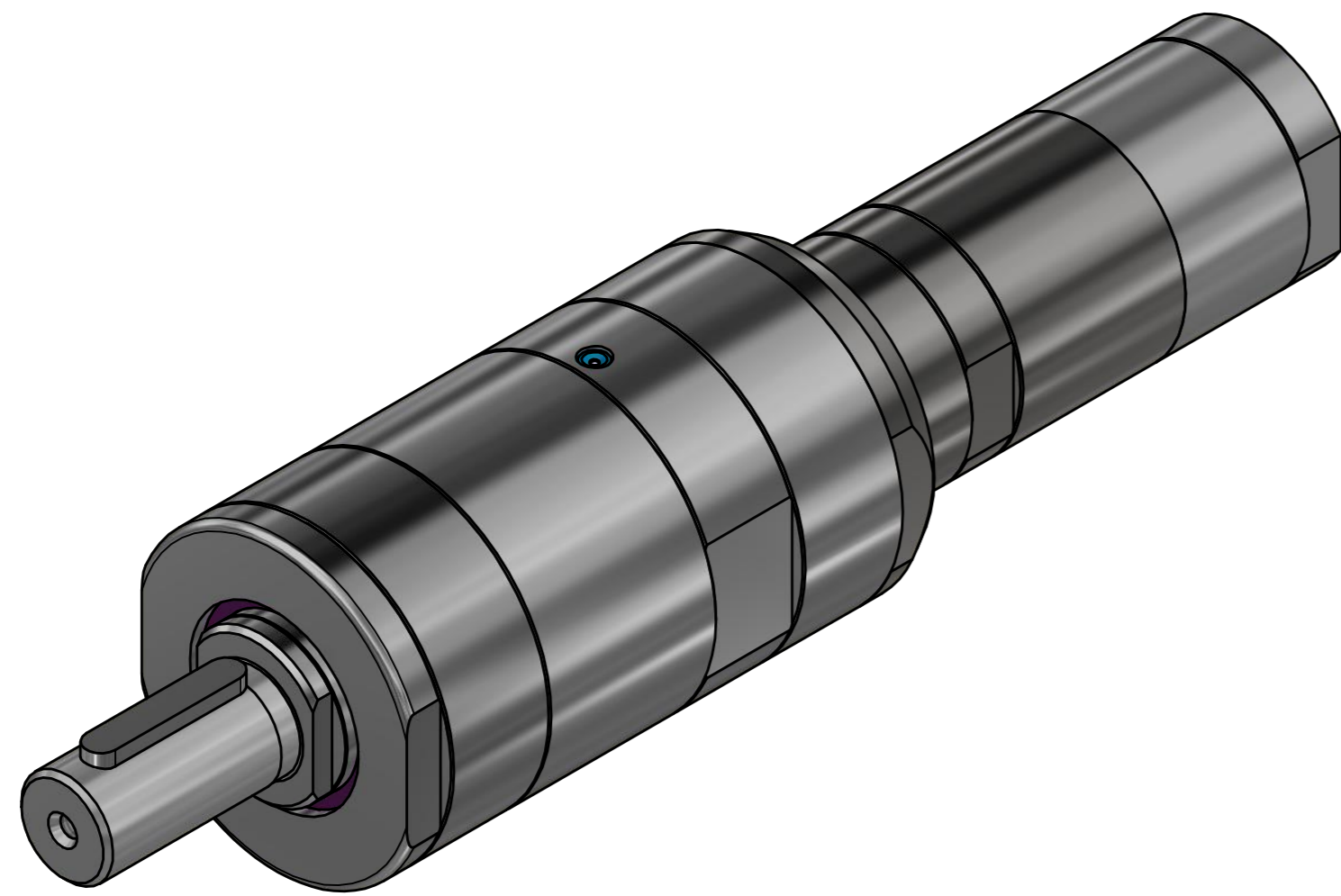
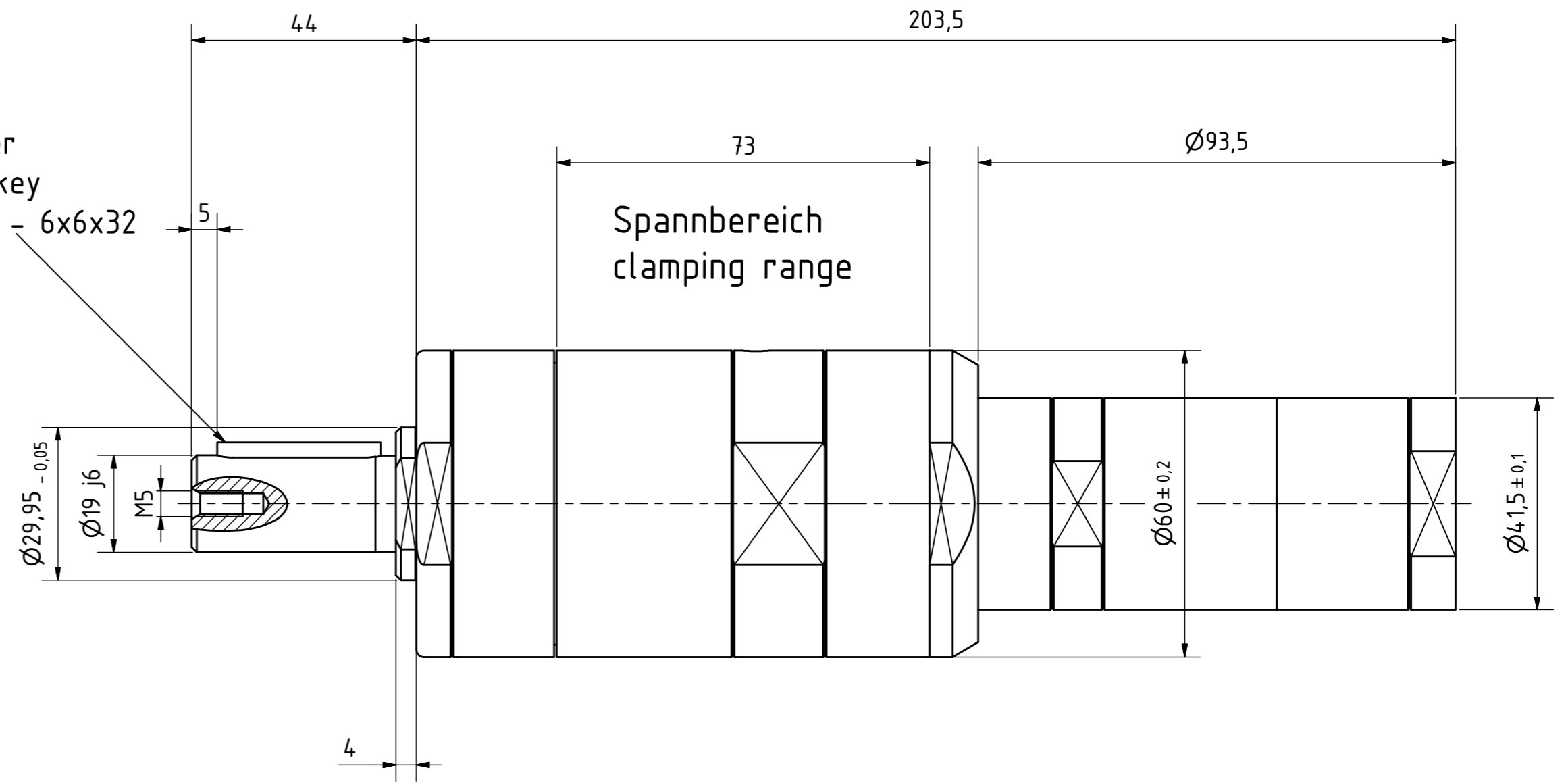

MUD 23-40
60008907

**MANNESMANN
DEMAC**

Änderungsstand: - 02.07.2018