

Paßfeder
feather key
DIN 6885 - 5x5x18

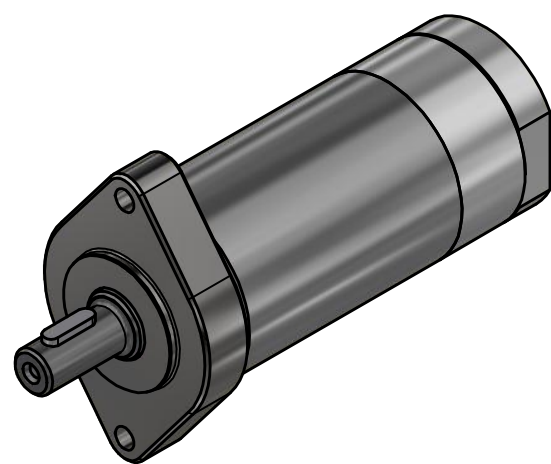
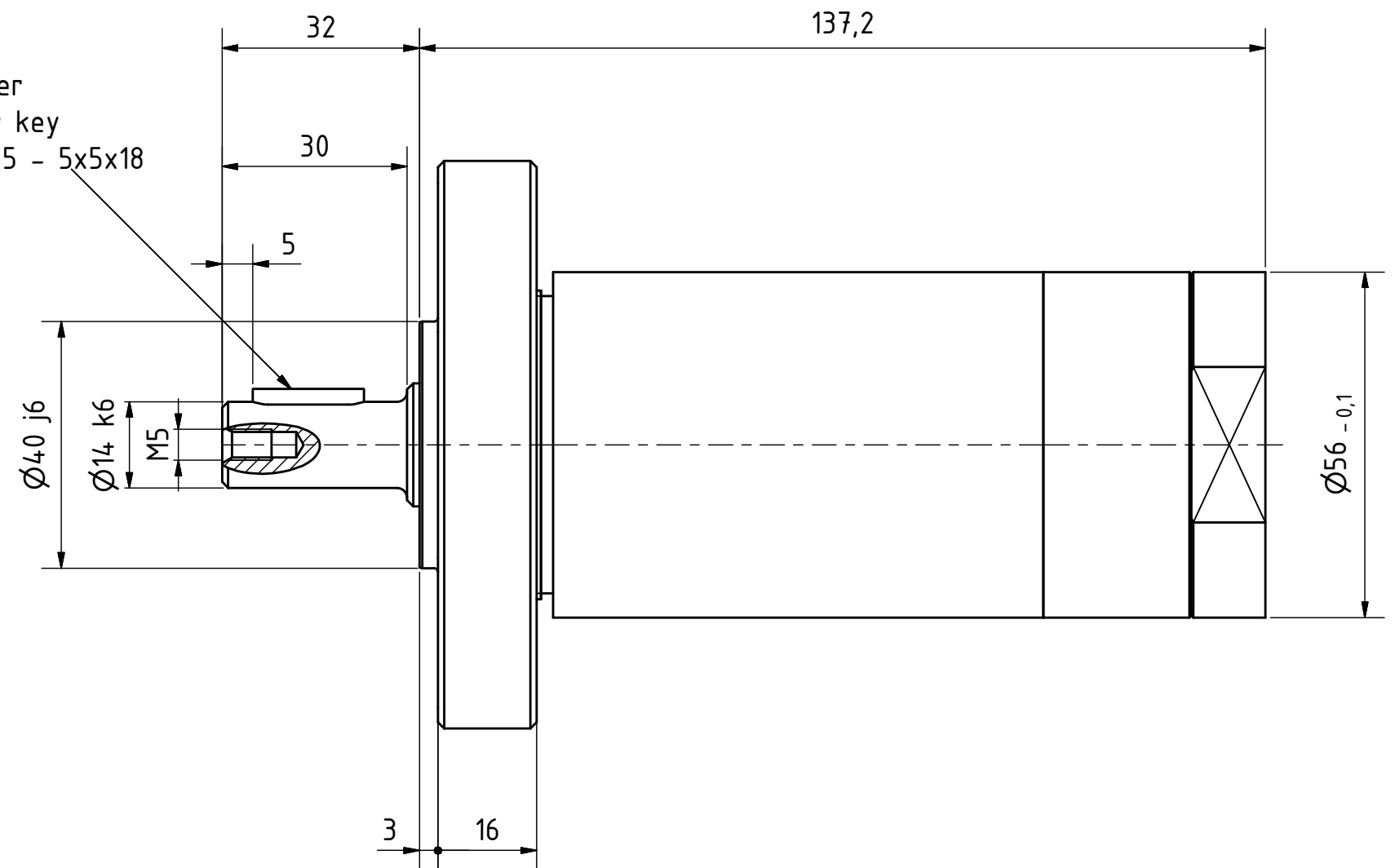

MUD 40-2400 F77
29906817

MANNESMANN
DEMAC

Änderungsstand: -

23.11.2018