

Paßfeder
 feather key
 DIN 6885 - 5x5x18

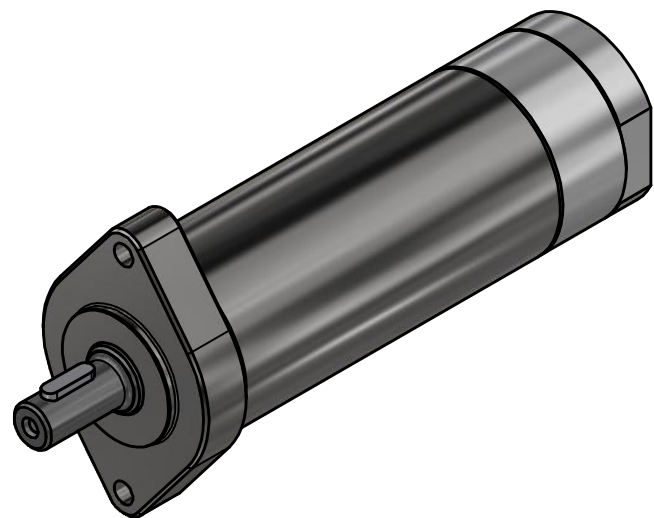
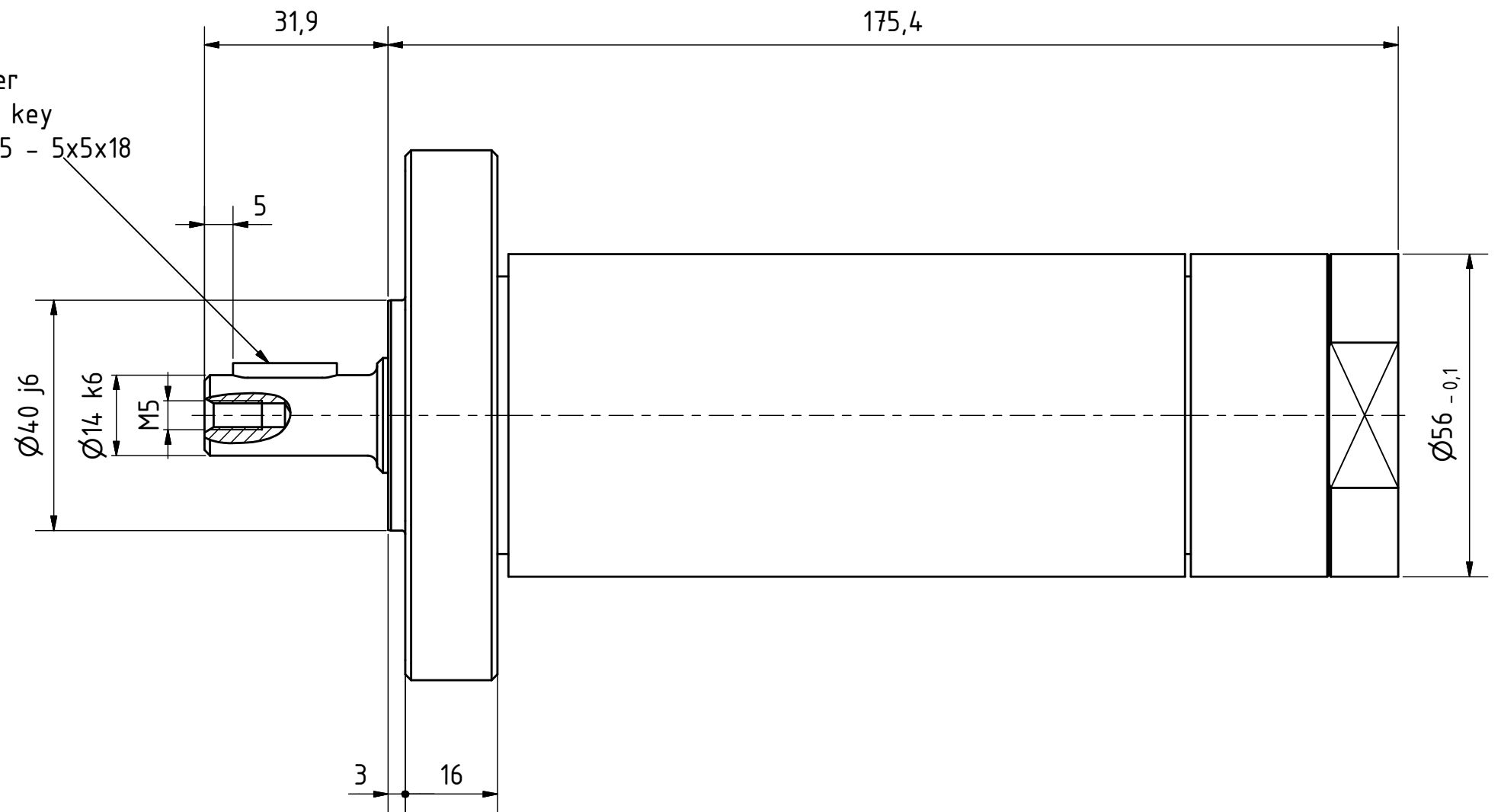

MUD 40-355 F77
 29906867

MANNESMANN
DEMAC

Änderungsstand: -

23.11.2018