

Paßfeder
 feather key
 DIN 6885 - 5x5x18

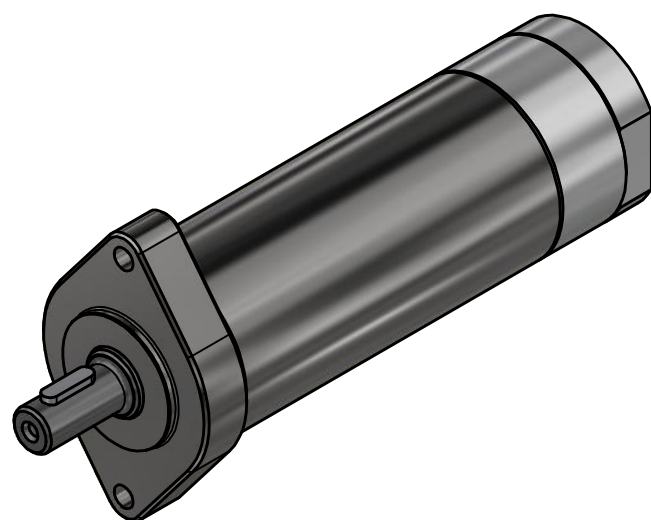
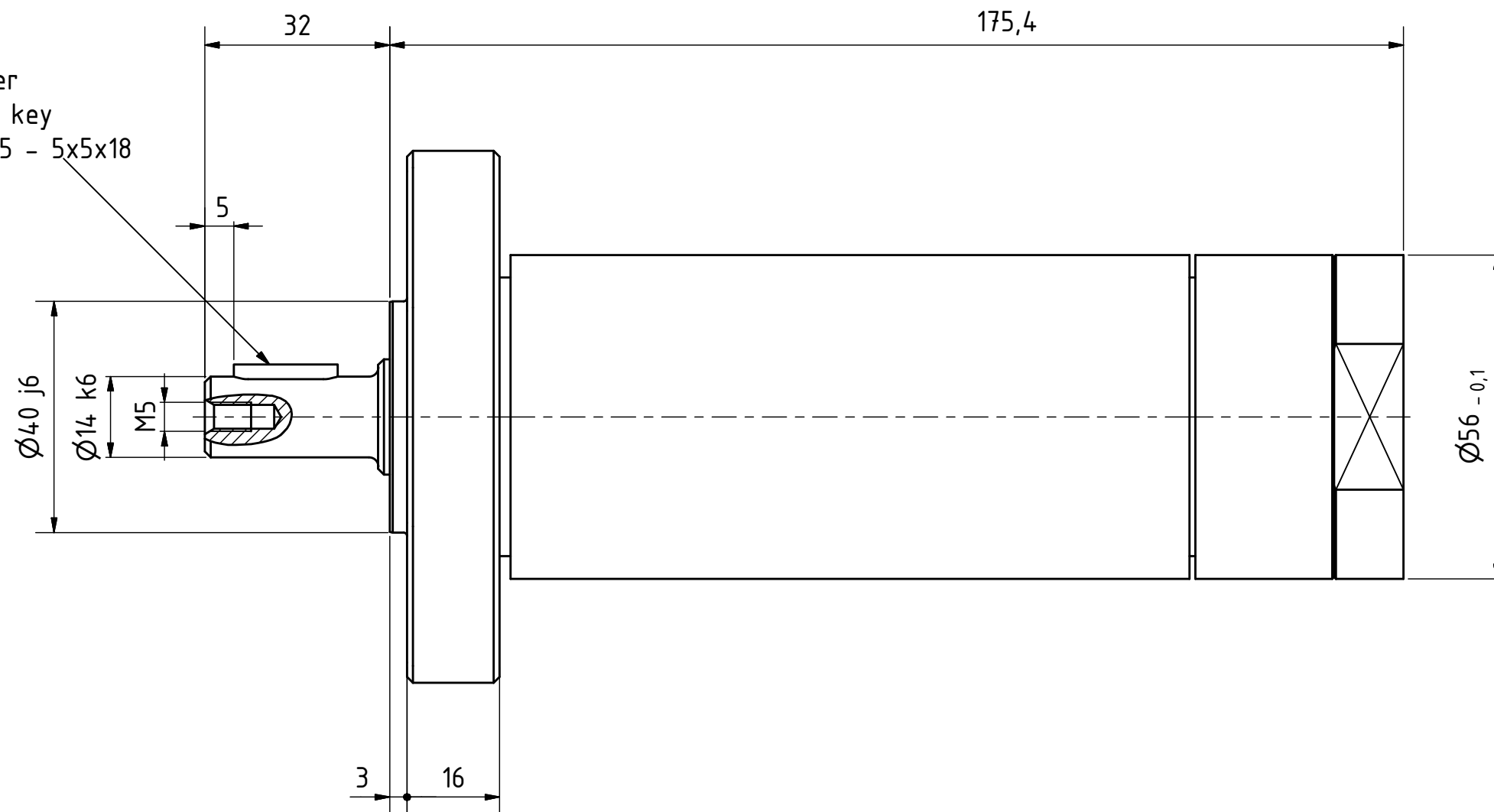

MUD 40-575 F77
 29906847

MANNESMANN
DEMAC

Änderungsstand: - 23.11.2018