

Passfeder
feather key
DIN 6885 - 5x5x30

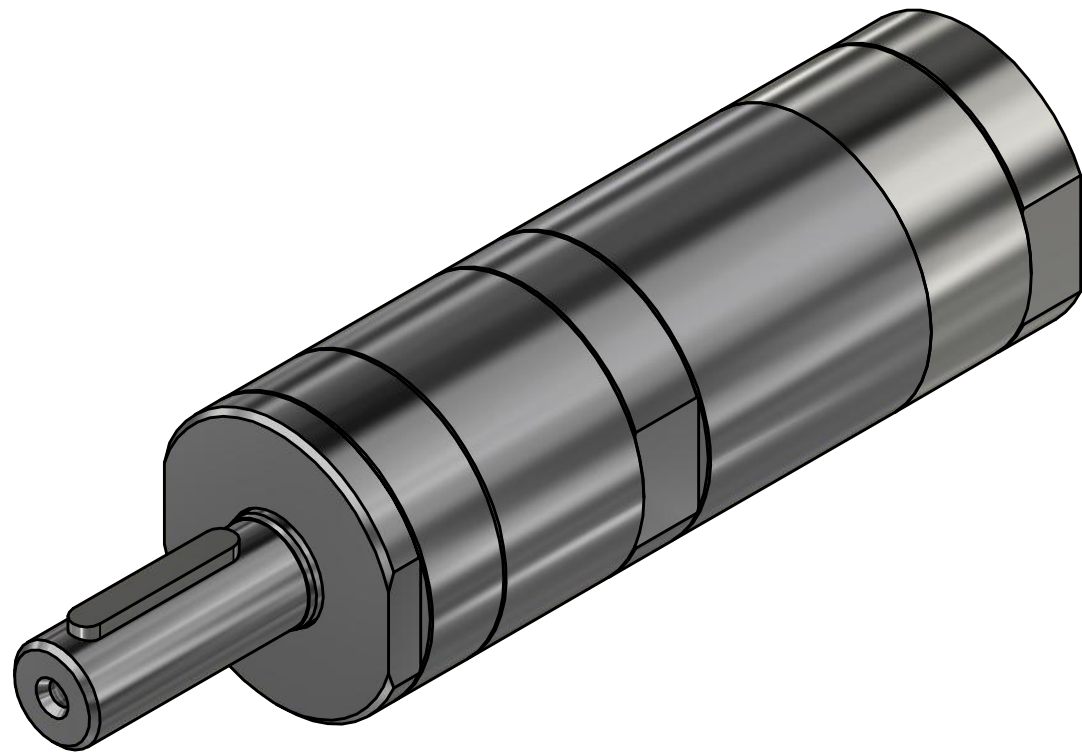
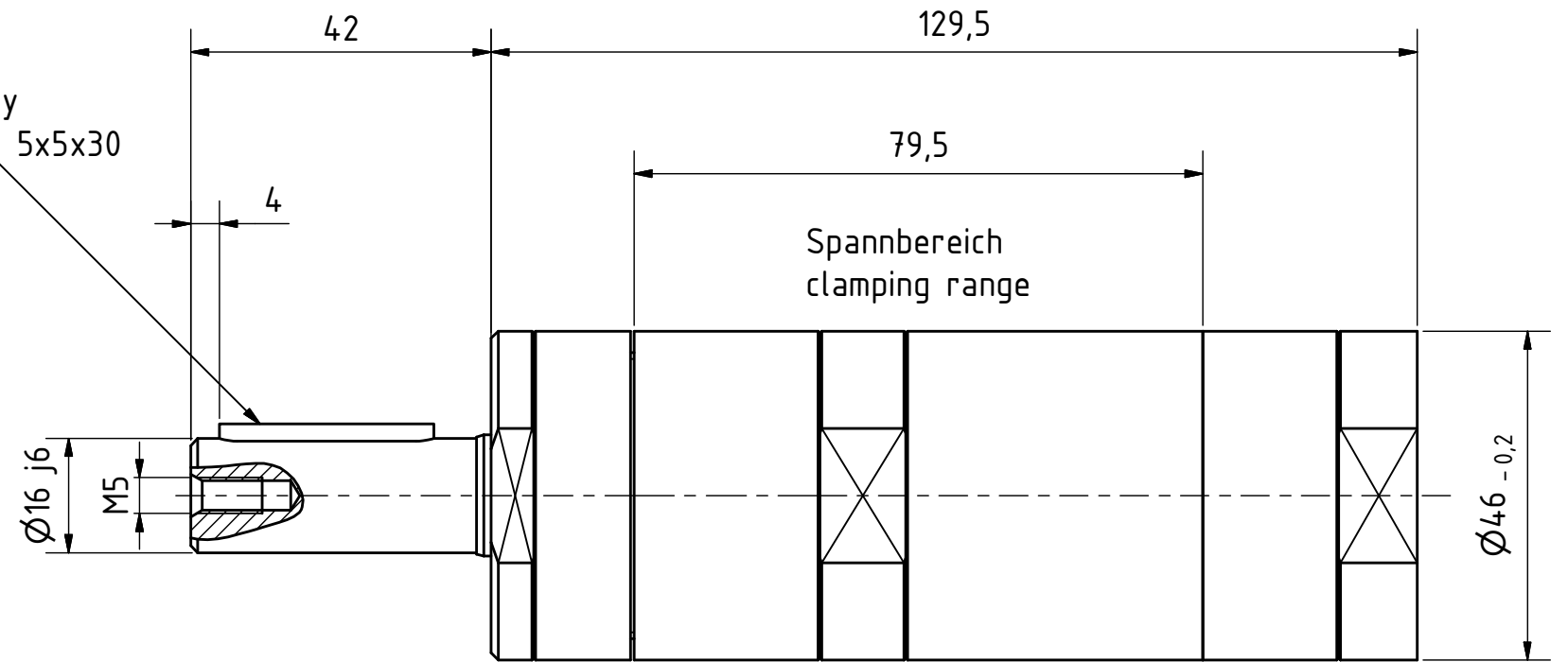

MUD 53-1780
60025137

MANNESMANN
DEMAC

Änderungsstand: - 28.11.2018