

Passfeder
 feather key
 DIN 6885 - 5x5x30

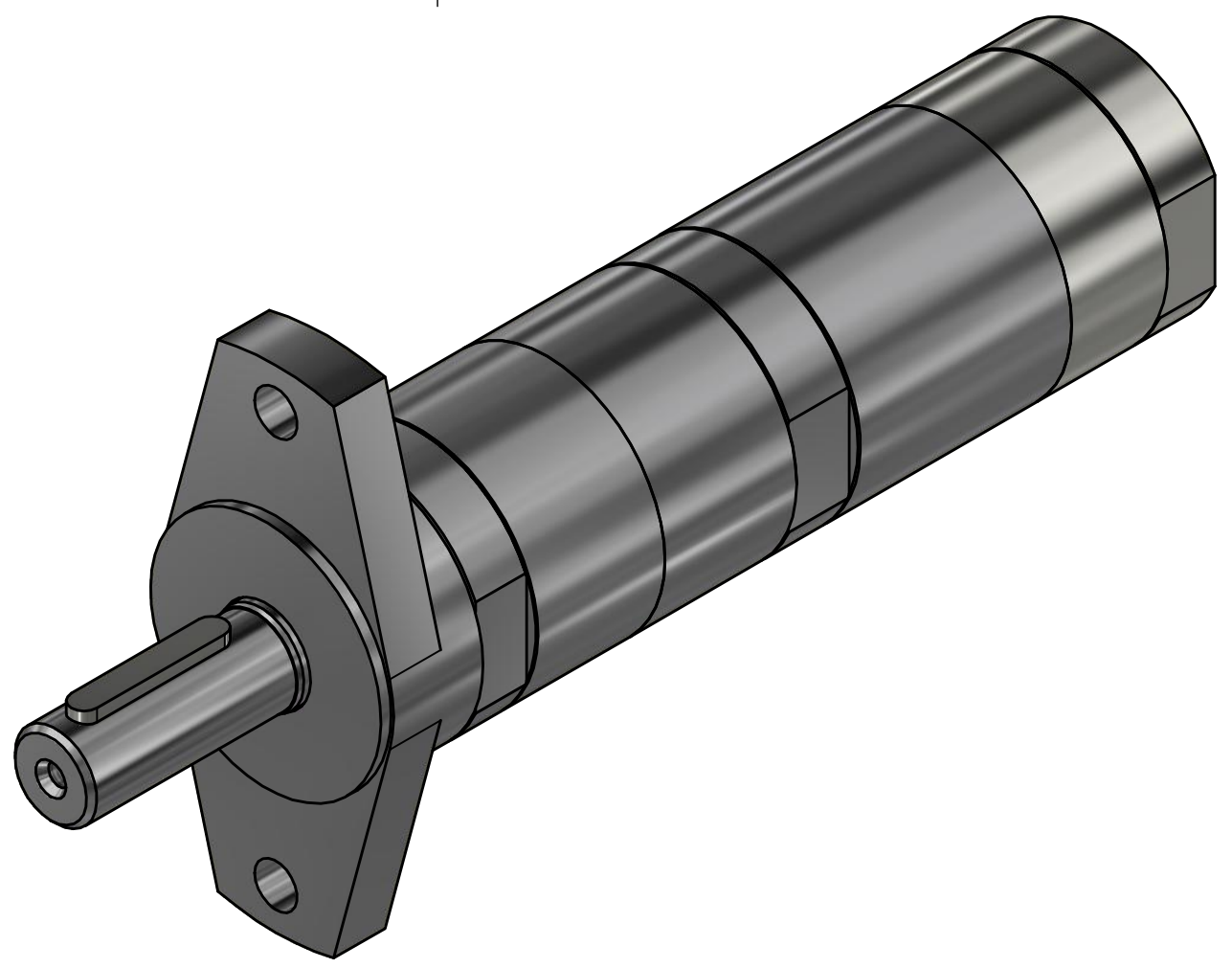
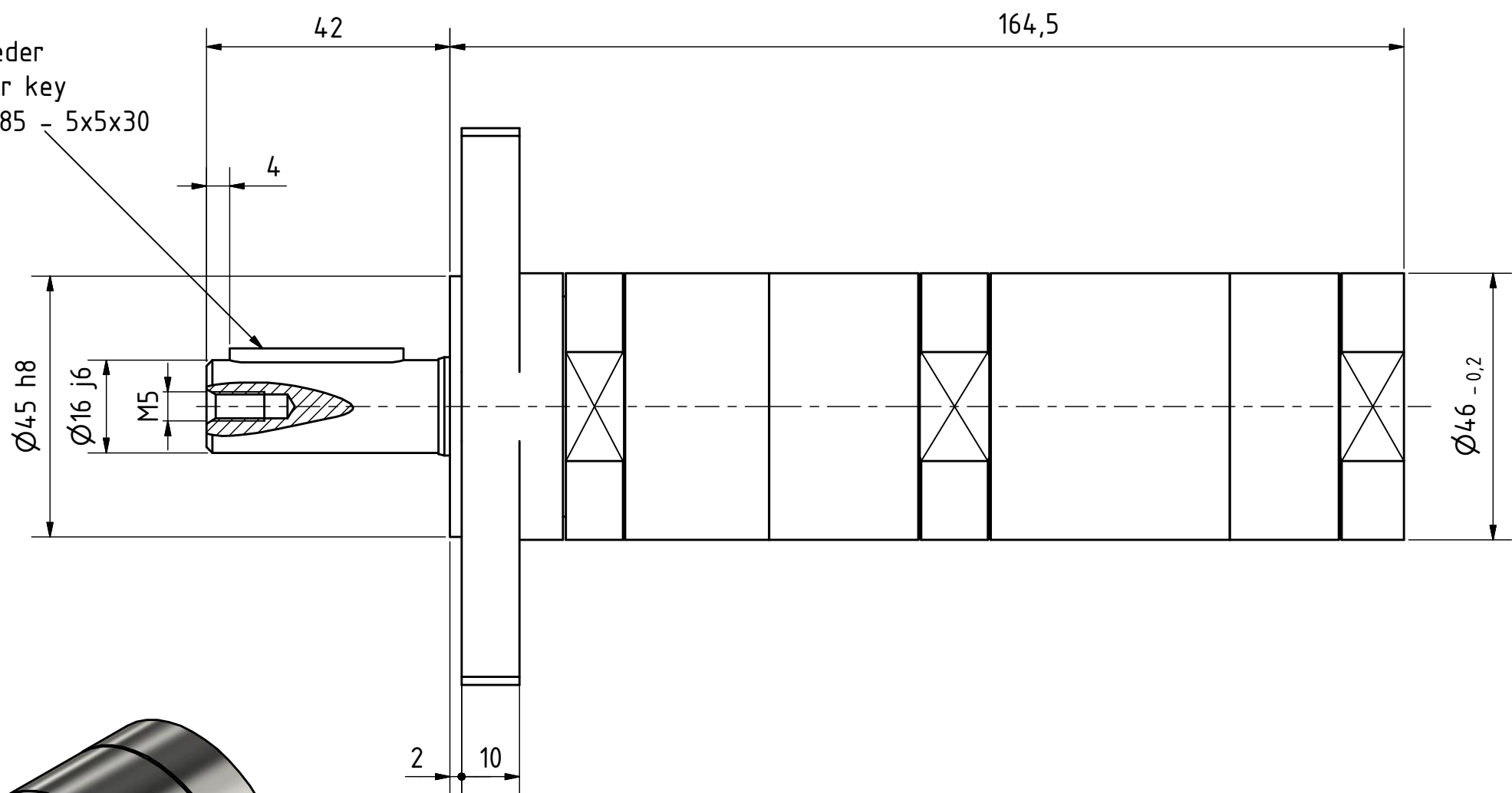

MUD 53-220 F80 60028527		MANNESMANN DEMAC
Änderungsstand: -	28.11.2018	