

Passfeder
feather key
DIN 6885 - 5x5x30

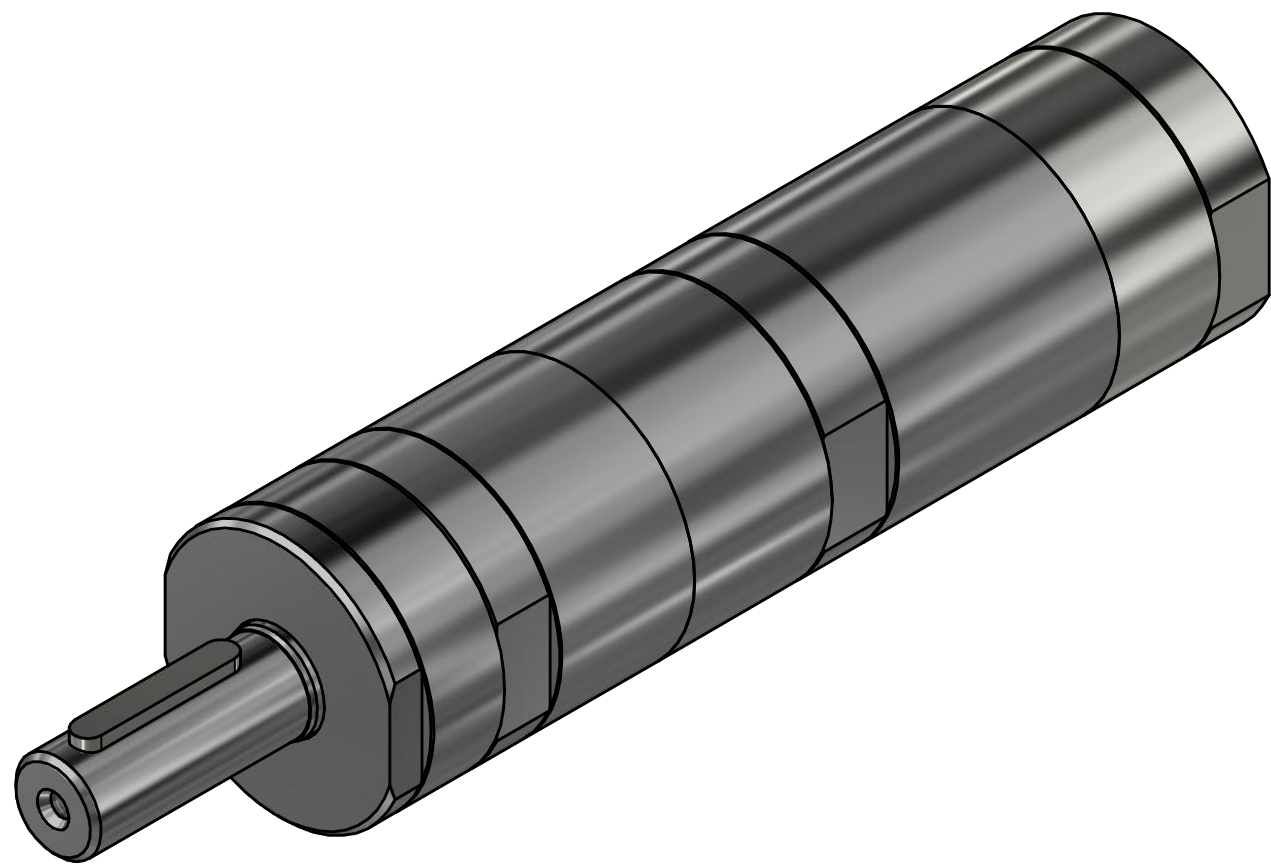
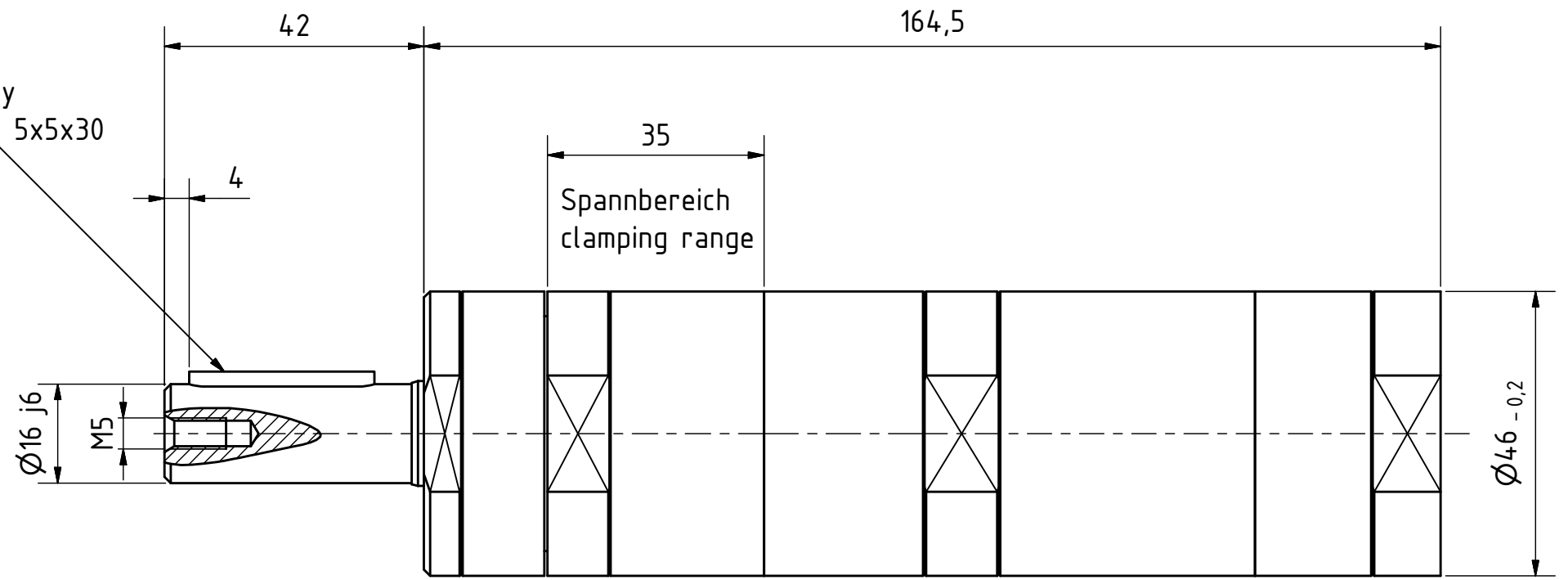

MUD 53-390
60025157

MANNESMANN
DEMAG

Änderungsstand: - 28.11.2018