

Passfeder
 feather key
 DIN 6885 - 6x6x32

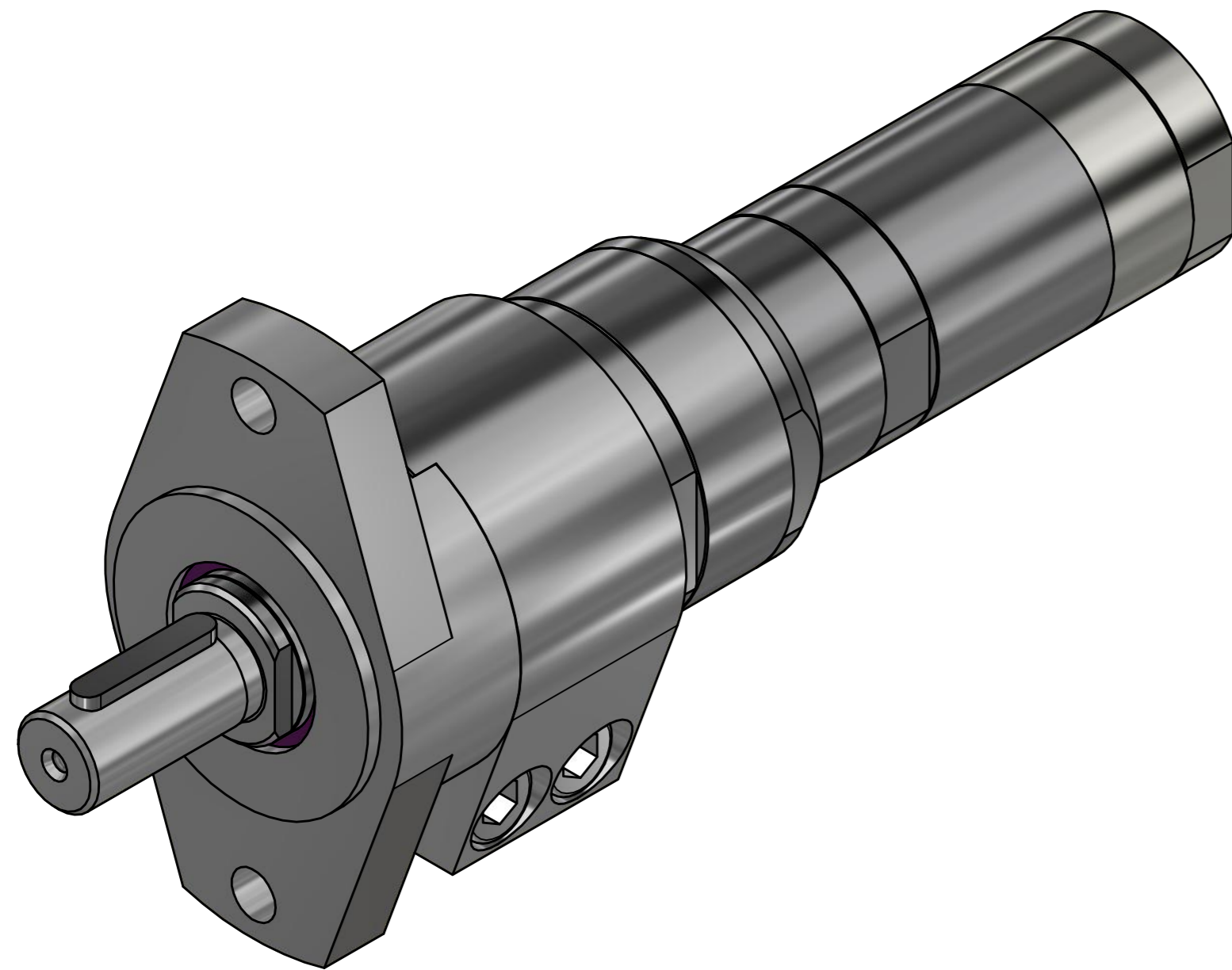
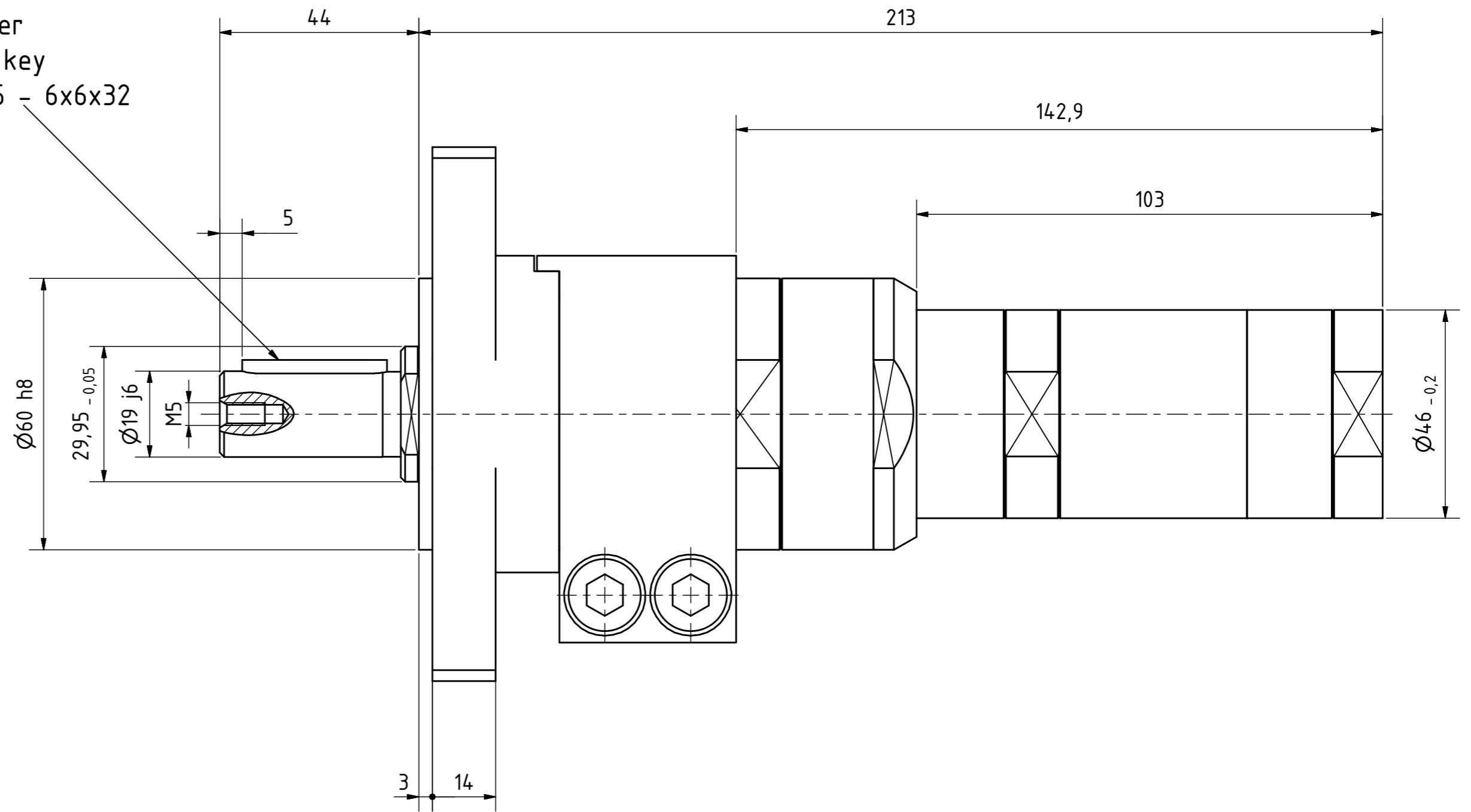

MUD 53-45 F100
 60031217

MANNESMANN
DEMAC

Änderungsstand: - 28.11.2018