

Passfeder
feather key
DIN 6885 - 6x6x32

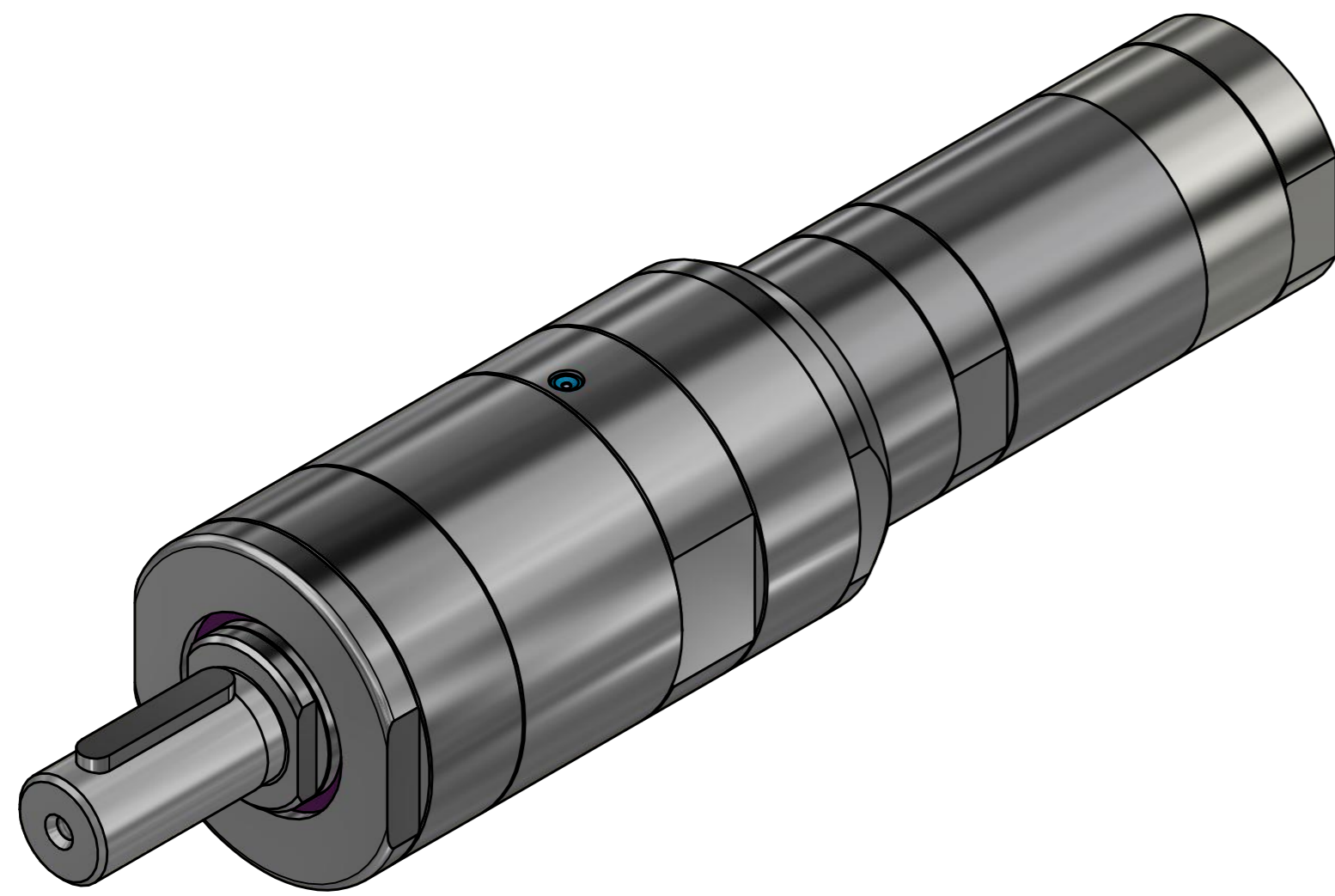
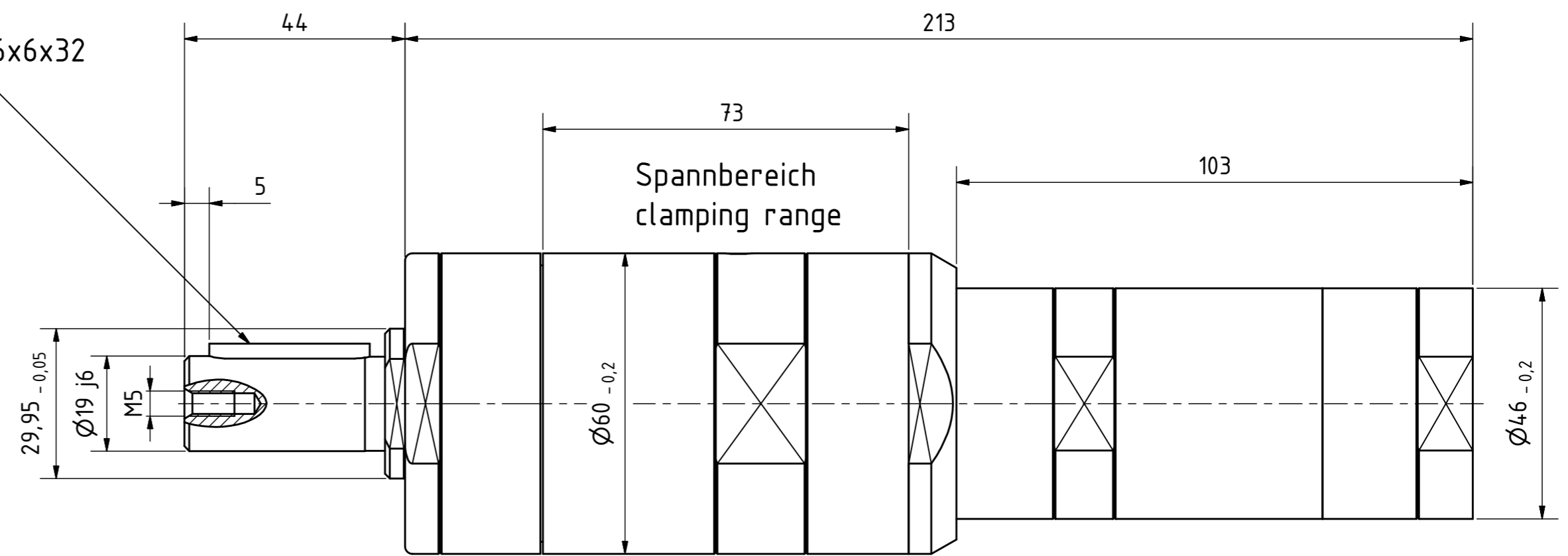

MUD 53-65
60025197

**MANNESMANN
DEMAC**

Änderungsstand: - 28.11.2018