

Passfeder
feather key
DIN 6885 - 5x5x30

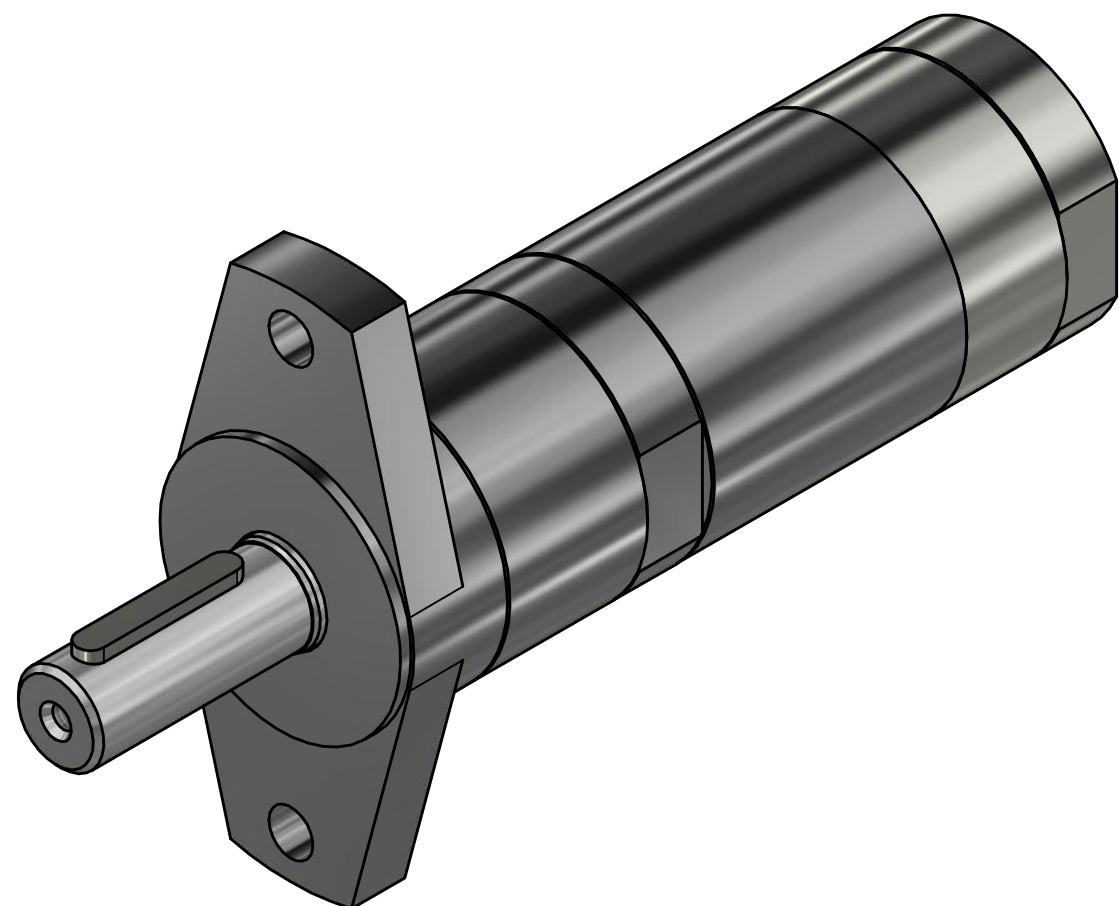
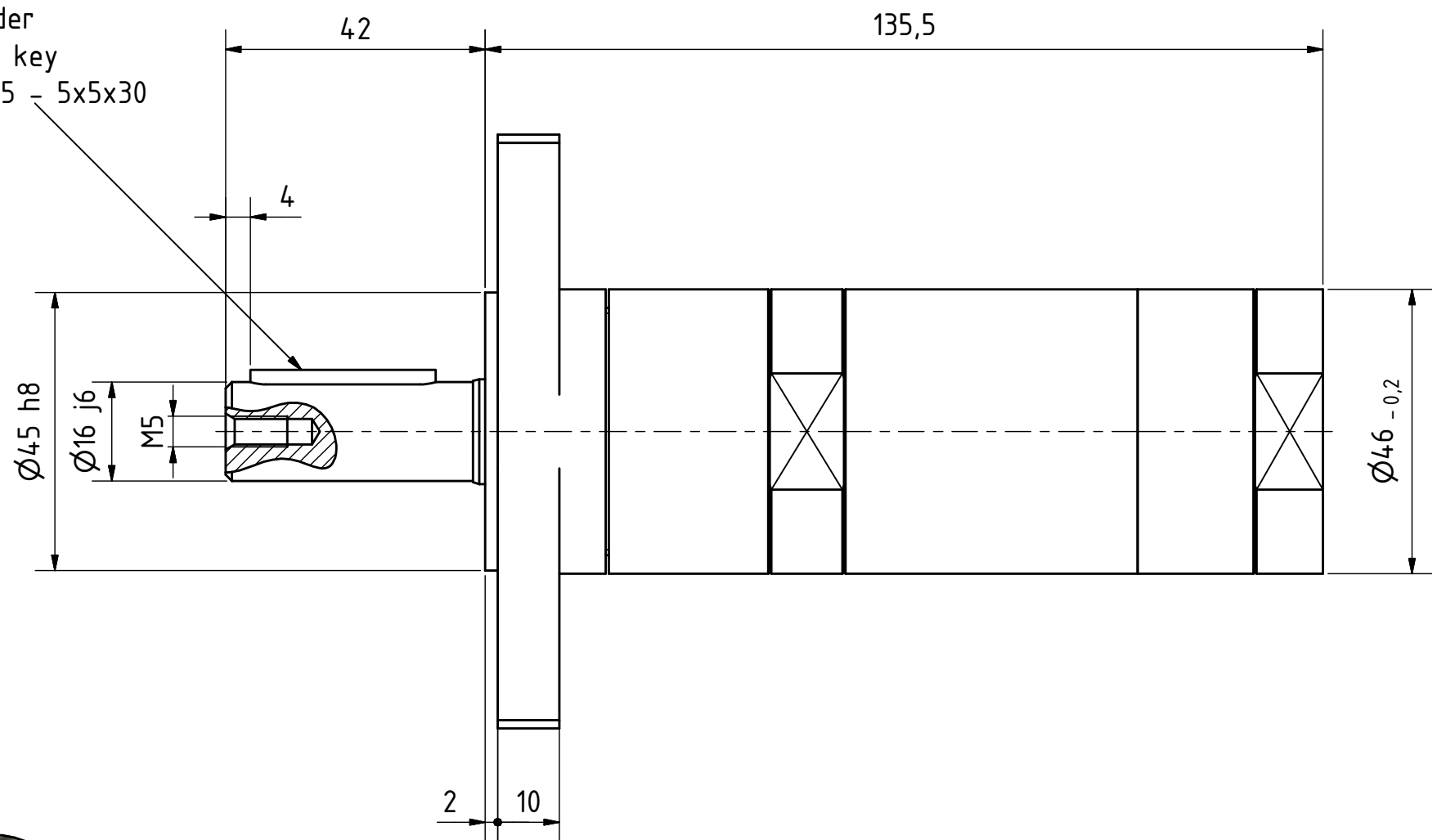

MUD 62-2400 F80
60031347

MANNESMANN
DEMAC

Änderungsstand: -

07.12.2018