

Passfeder
feather key
DIN 6885 - 5x5x30

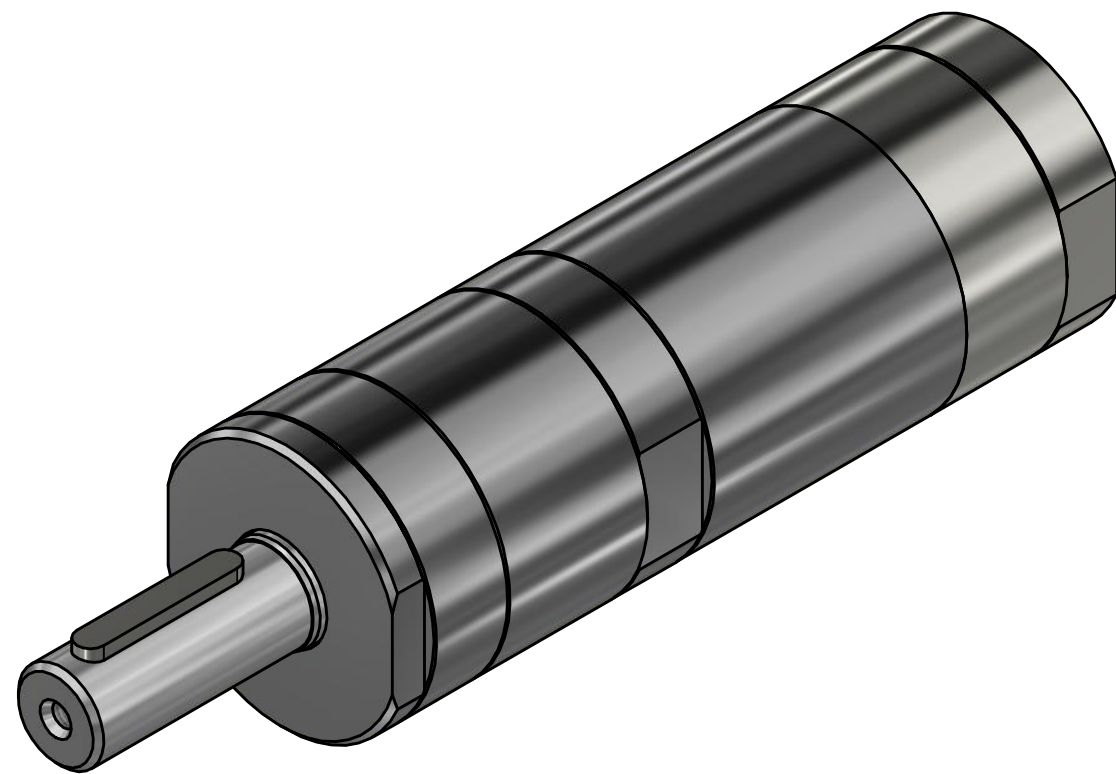
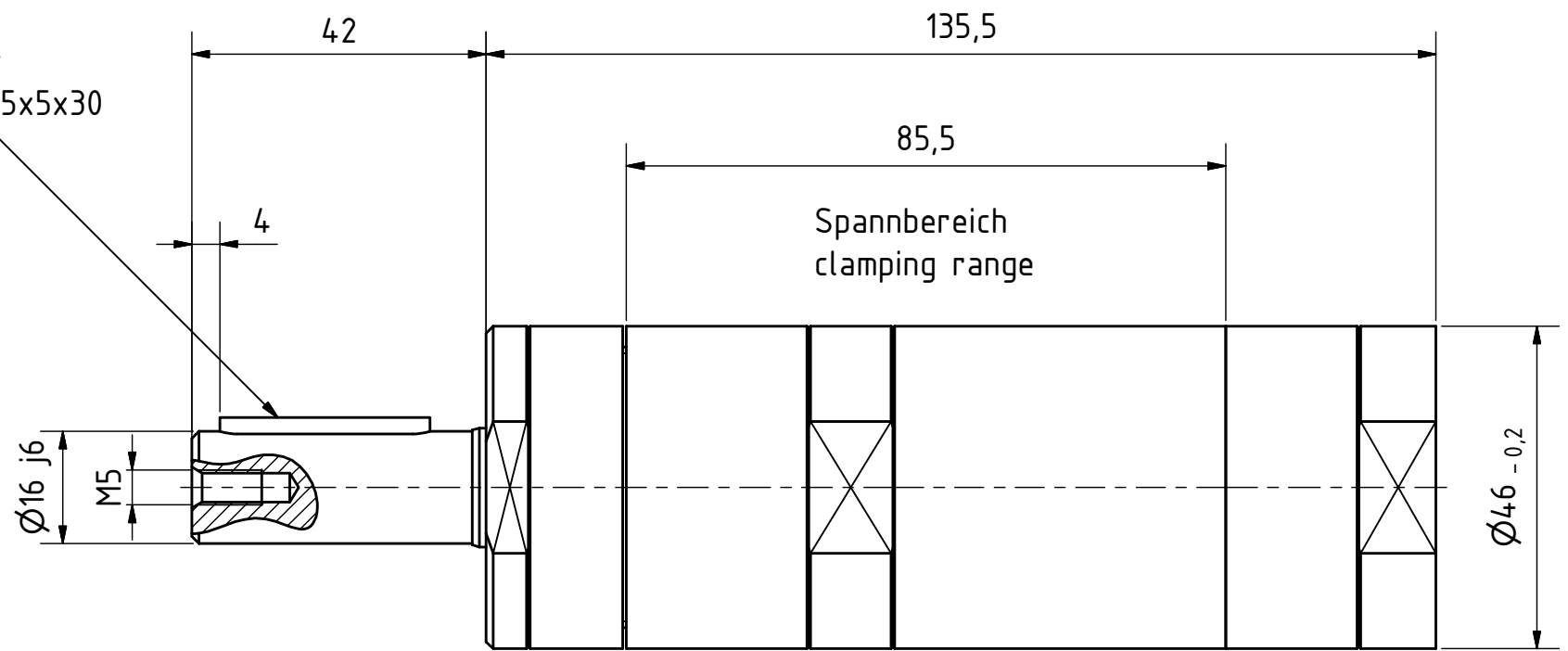

MUD 62-2400
60025417

MANNESMANN
DEMAG

Änderungsstand: - 07.12.2018