

Scheibenfeder
woodruff key
DIN 6888 - 3x3,7x9,66

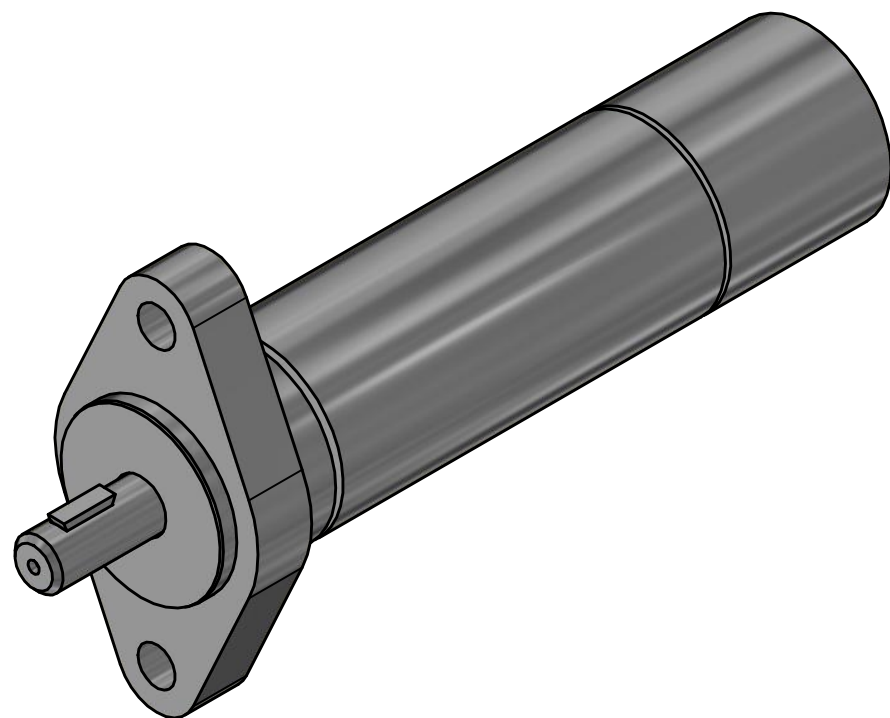
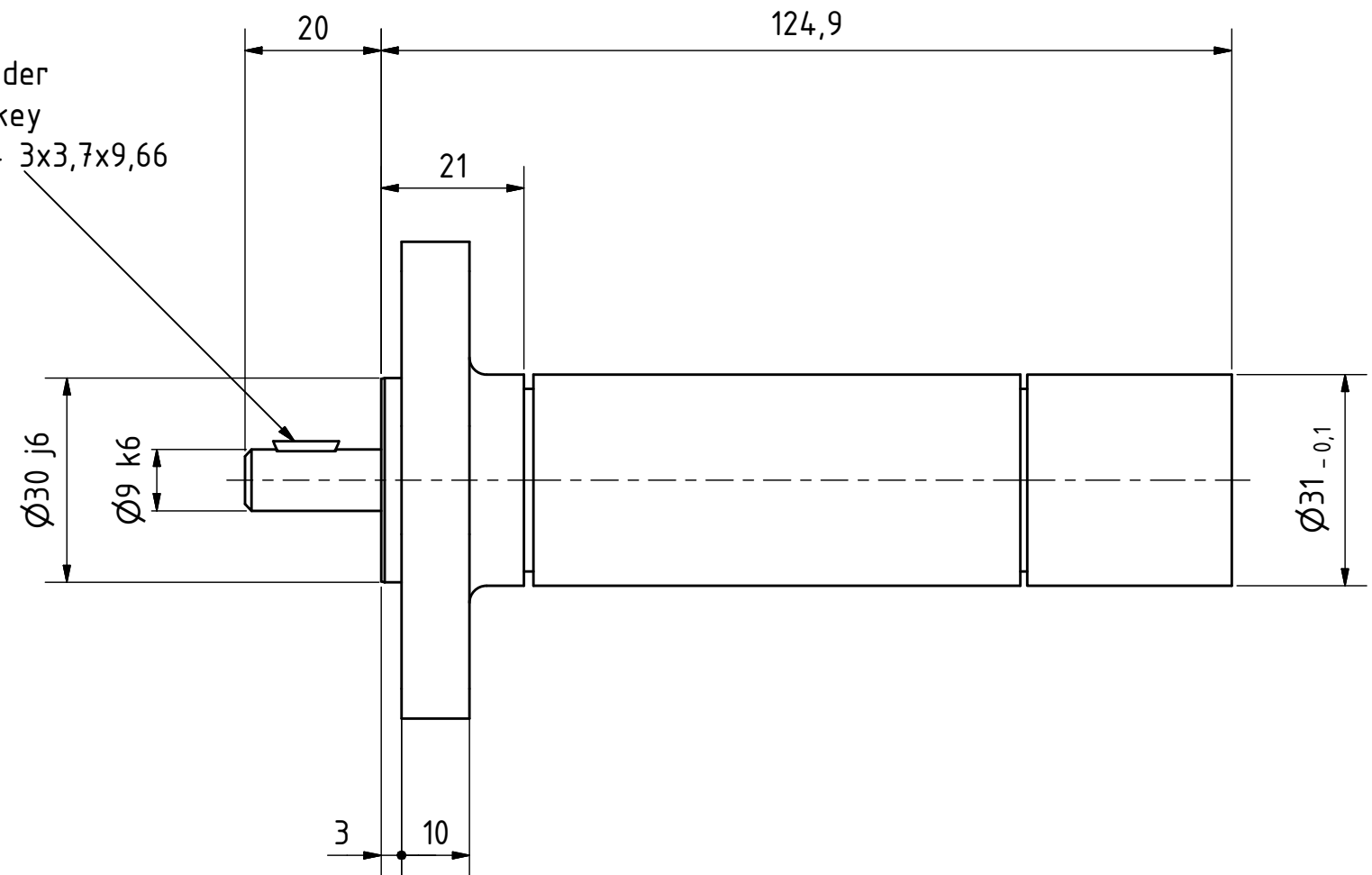

MUD 9-330 F55
29906477

MANNESMANN
DEMAC

Änderungsstand:

14.11.2018