

Scheibenfeder
 woodruff key
 DIN 6888 - 3x3,7x9,66

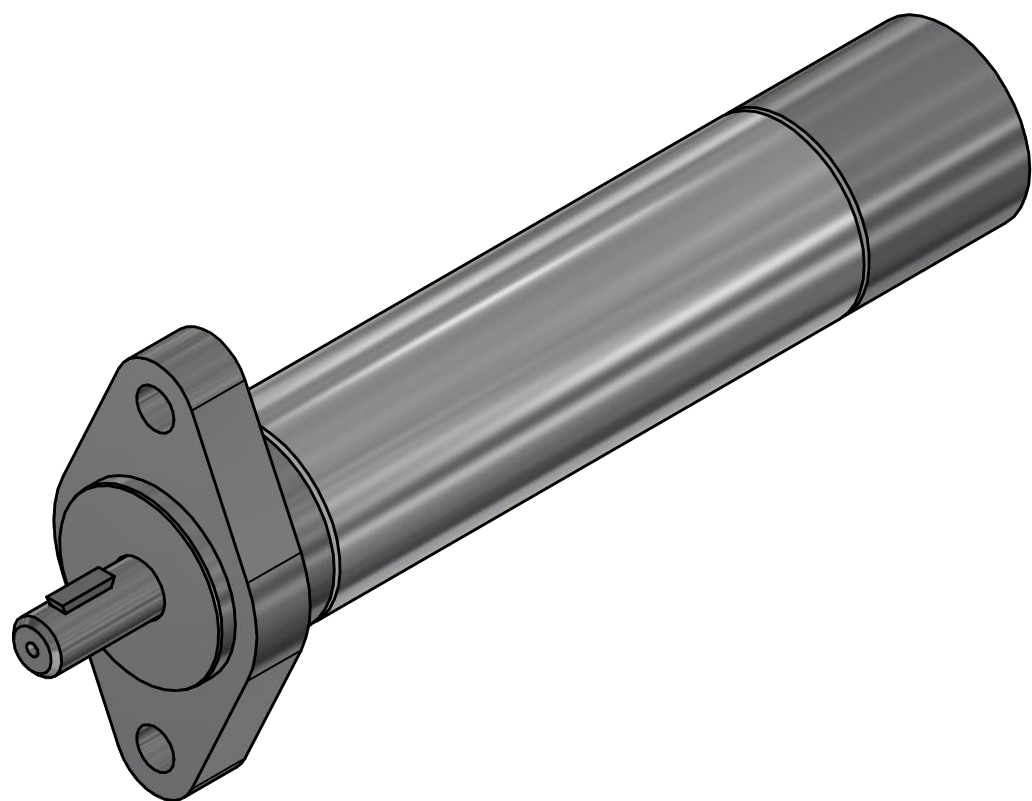
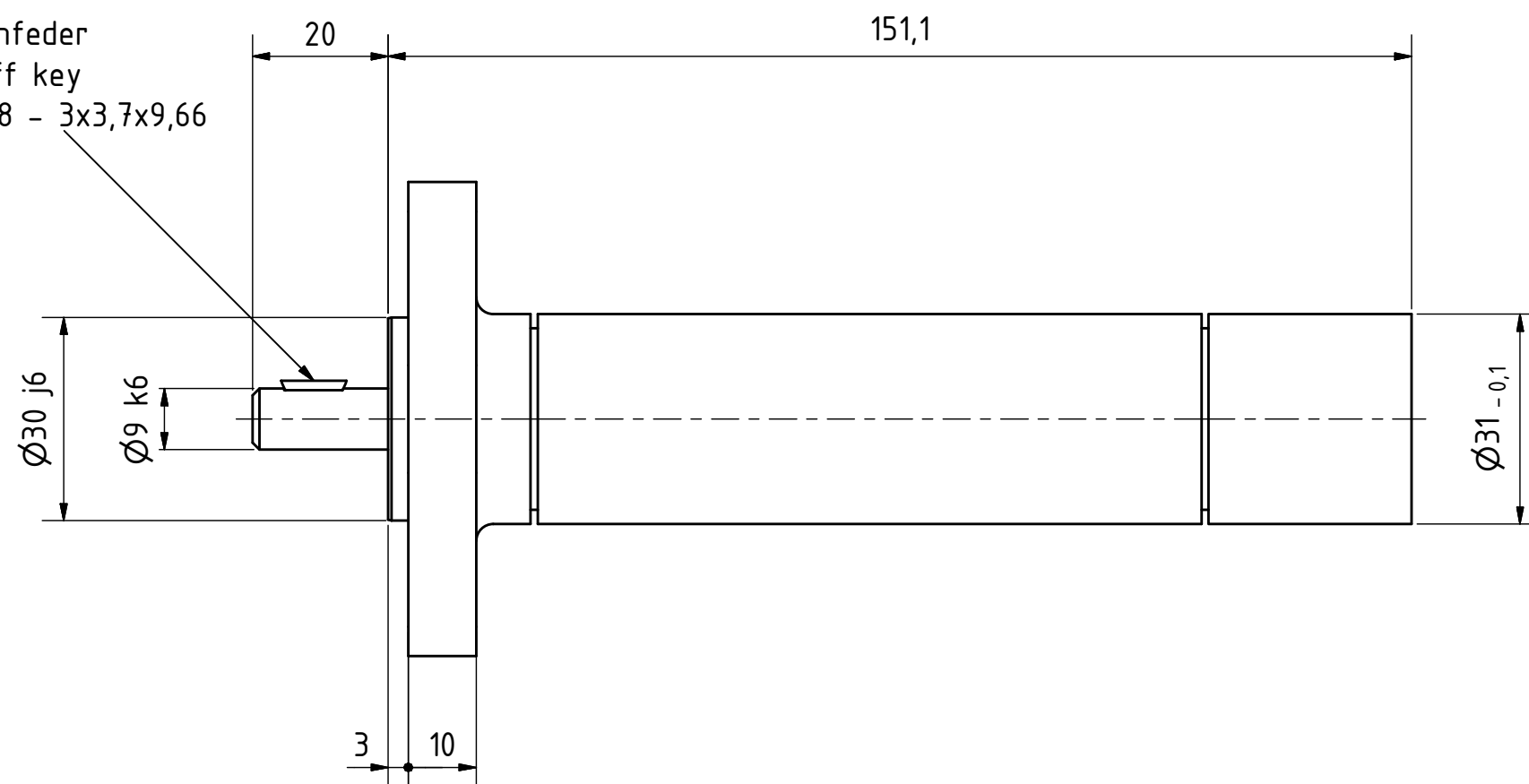

MUD 9-96 F55
 29907217

MANNESMANN
DEMAG

Änderungsstand:

14.11.2018